

1 2 3 4 5 6 7 8

A

B

C

D

E

F

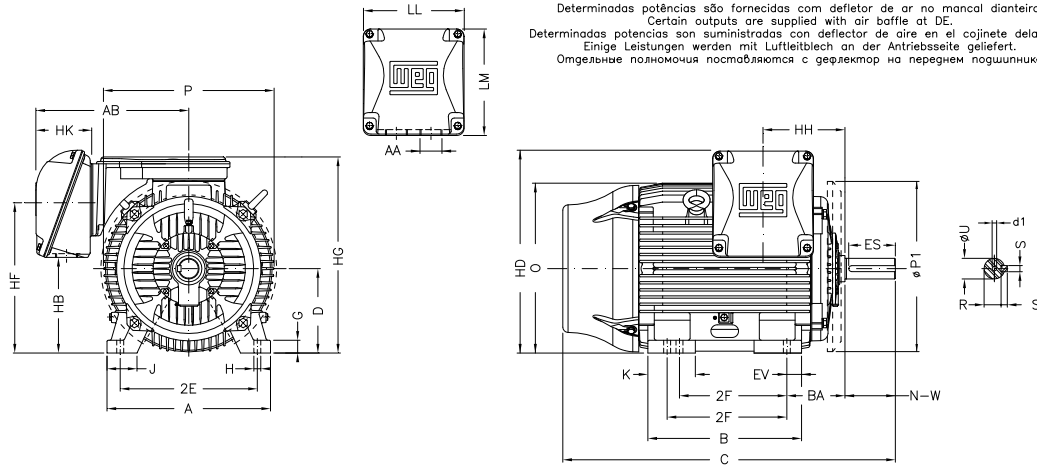

Notes: Downloaded from <http://dealerselectric.com>
Generated for Model #35012ET3GRB449T-W22

2E 18.000	J 3.937	A 21.929	P 25.866	AB 23.720
2F 20.000/25.000	K 11.688	B 31.535	BA 7.500	U 3.375
N-W 8.500	ES 7.087	S 0.875	R 2.880	depth 0.875
D 11.000	G 1.630	HB 11.535	O 23.874	HD 30.708
HF 20.551	HG 28.185	HH 11.870	HK 8.661	EV 2.638
H 0.810	C 57.181	LL 15.906	LM 17.165	AA 2xNPT 3"
d1 DUNC 3/4"-10				

Performed by:

Checked:

Customer:

W22 NEMA Premium - Roller Bearings

Three-phase induction motor
Frame L447/9T - IP55

29-SEP-2016

