

1 2 3 4 5 6 7 8

A

B

C

D

E

F

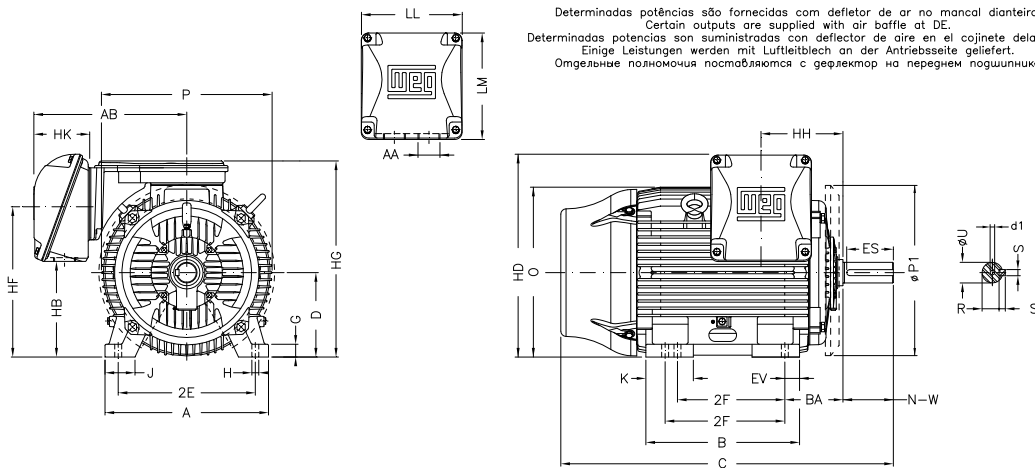

Determinadas potências são fornecidas com defletor de ar no mancal dianteiro.
 Certain outputs are supplied with air baffle at DE.
 Determinadas potencias son suministradas con deflector de aire en el cojinete delantero.
 Einige Leistungen werden mit Luftblech an der Antriebsseite geliefert.
 Отдельные полнomoчия поставляются с дефлектор на переднем подшипнике.

Notes: Downloaded from <http://dealerselectric.com>
 Generated for Model #35009EP3G586/7-W22

Performed by:

Checked:

Customer:

W22 High Efficiency

Three-phase induction motor
 Frame 586/7T - IP55

29-SEP-2016



2E 23.000	J 5.512	A 29.528	P 28.977	AB 23.189
2F 22.000/25.000	K 9.055	B 29.921	BA 10.000	U 3.875
N-W 11.625	ES 8.661	S 1.000	R 3.312	depth 1.000
D 14.500	G 2.492	HB 18.575	O 28.985	HD 35.740
HF 26.732	HG 35.236	HH 13.346	HK 8.661	H 1.181
C 61.902	LL 15.906	LM 17.165	AA 2xNPT 3"	d1 DUNC 7/8"-9