

1 2 3 4 5 6 7 8

A

B

C

D

E

F

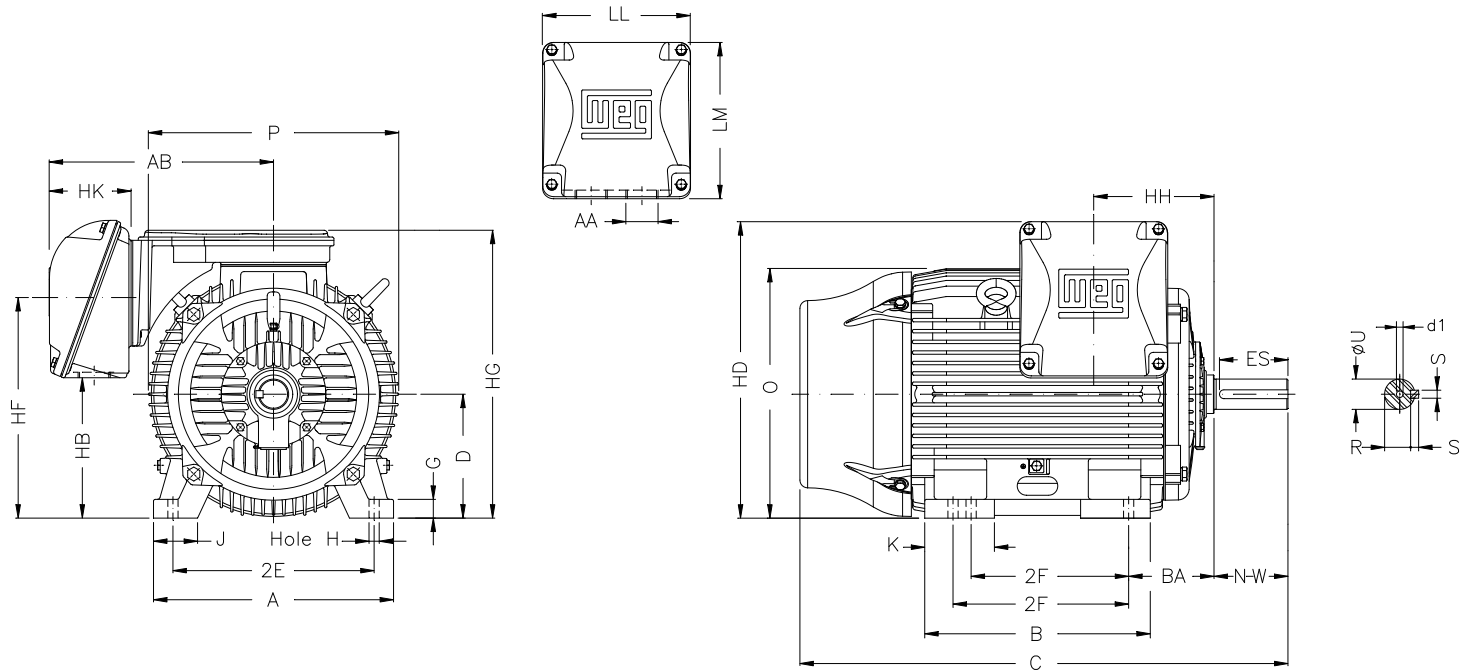

Notes: Downloaded from <http://dealerselectric.com>
Generated for Model #25018EP3G447T-W22

Performed by:

Checked:

Customer:

W22 High Efficiency

Three-phase induction motor
Frame 445/7T - IP55

28-SEP-2016



2E 18.000	J 3.937	A 21.929	P 23.583	AB 20.559
2F 16.500/20.000	K 7.244	B 23.897	BA 7.500	U 3.375
N-W 8.500	ES 7.087	S 0.875	R 2.880	depth 0.875
D 11.000	G 1.654	HB 12.488	O 22.795	HD 27.527
HF 20.724	HG 26.830	HH 11.811	HK 6.929	H 0.810
C 48.701	LL 14.921	LM 15.039	AA 2xNPT 3"	d1 DUNC 3/4"-10