

1 2 3 4 5 6 7 8

A

B

C

D

E

F

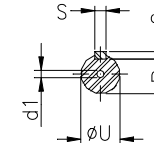
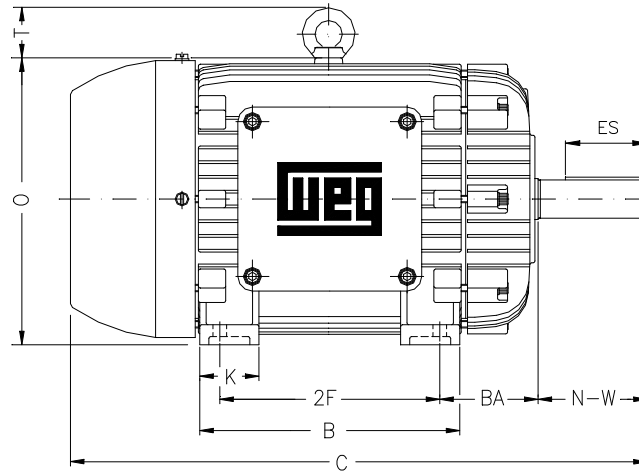

Notes: Downloaded from <http://dealerselectric.com>
Generated for Model #25012XT3G449T

Performed by:

Checked:

Customer:

Three-Phase : Explosion Proof - NEMA Premium

Three-phase induction motor
Frame 449T - IP55

28-SEP-2016



| | | | | |
|--------------|----------------|--------------------|--------------------|----------------|
| 2E 18.000 | A 21.929 | 2F 25.000 | B 32.126 | BA 7.500 |
| J 3.937 | K 7.104 | P 24.016 | ES 7.087 | depth 0.875 |
| S 0.875 | N-W 8.500 | U 3.375 | R 2.880 | AB 20.984 |
| D 11.000 | G 1.630 | O 23.622 | T 3.543 | H 0.807 |
| C 54.996 | AA 2xNPT 3" | d1 DUNC 3/4"-10 | d2 DUNC 3/4"-10 | |