

1 2 3 4 5 6 7 8

A

B

C

D

E

F

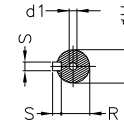
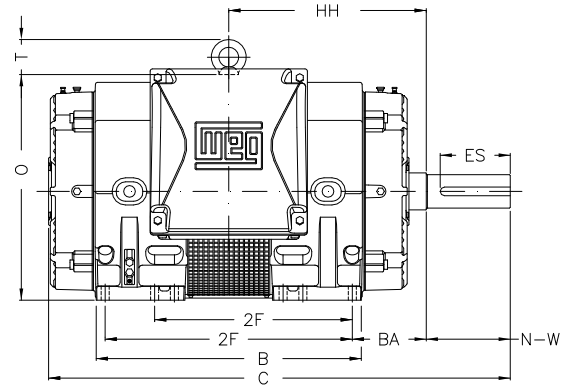
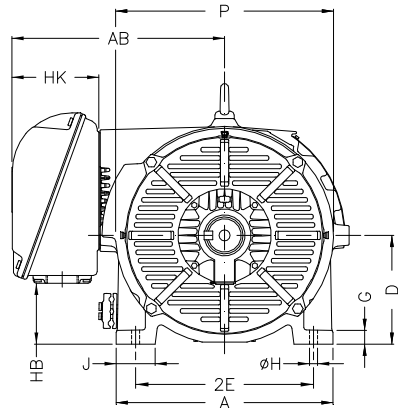
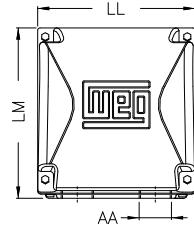

Notes: Downloaded from <http://dealerselectric.com>  
Generated for Model #250120T3G447/9T-W40

2E 18.000	J 3.983	A 21.929	P 25.197	AB 21.505
2F 20.000/25.000	K 8.971	B 26.820	FK 8.971	EV 0.910
BA 7.480	U 3.375	d1 DUNC 7/8"-9	N-W 8.500	ES 7.087
S 0.875	R 2.882	depth 0.875	D 11.000	G 1.397
O 22.811	T 3.543	HH 19.980	H 0.810	C 46.709
AA 2xNPT 3"	DM NPT 3/4"	LL 15.904	LM 17.225	HK 8.907
HB 6.158				

Performed by:

Checked:

Customer:

W40 - Open Induction Motors – NEMA Premium Efficiency

Three-phase induction motor  
Frame 447/9T - IP23

28-SEP-2016

