

1 2 3 4 5 6 7 8

A

B

C

D

E

F

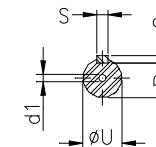
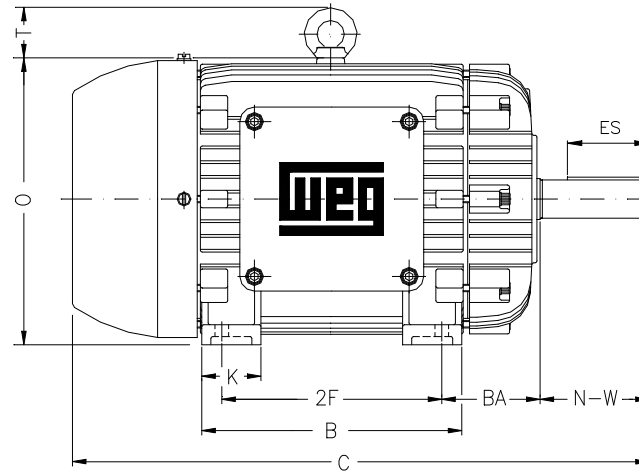
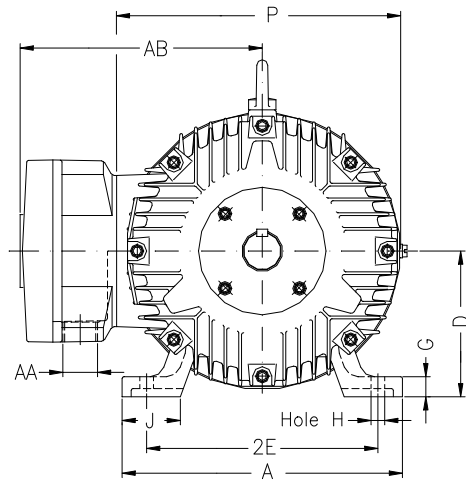

Notes: Downloaded from <http://dealerselectric.com>
Generated for Model #15036XT3G445TS

Performed by:

Checked:

Customer:

Three-Phase : Explosion Proof - NEMA Premium

Three-phase induction motor
Frame 444/5TS - IP55

28-SEP-2016



2E 18.000	A 21.929	2F 14.500/16.500	B 20.079	BA 7.500
J 3.937	FBA 11.769/13.769	K 5.591	P 24.016	ES 3.000
depth 0.625	S 0.625	N-W 4.750	U 2.375	R 2.021
AB 21.732	D 11.000	G 1.630	O 23.622	T 3.543
H 0.807	C 40.047	AA 2xNPT 3"	d1 DUNC 3/4"-10	d2 DUNC 3/4"-10