

1 2 3 4 5 6 7 8

A

B

C

D

E

F

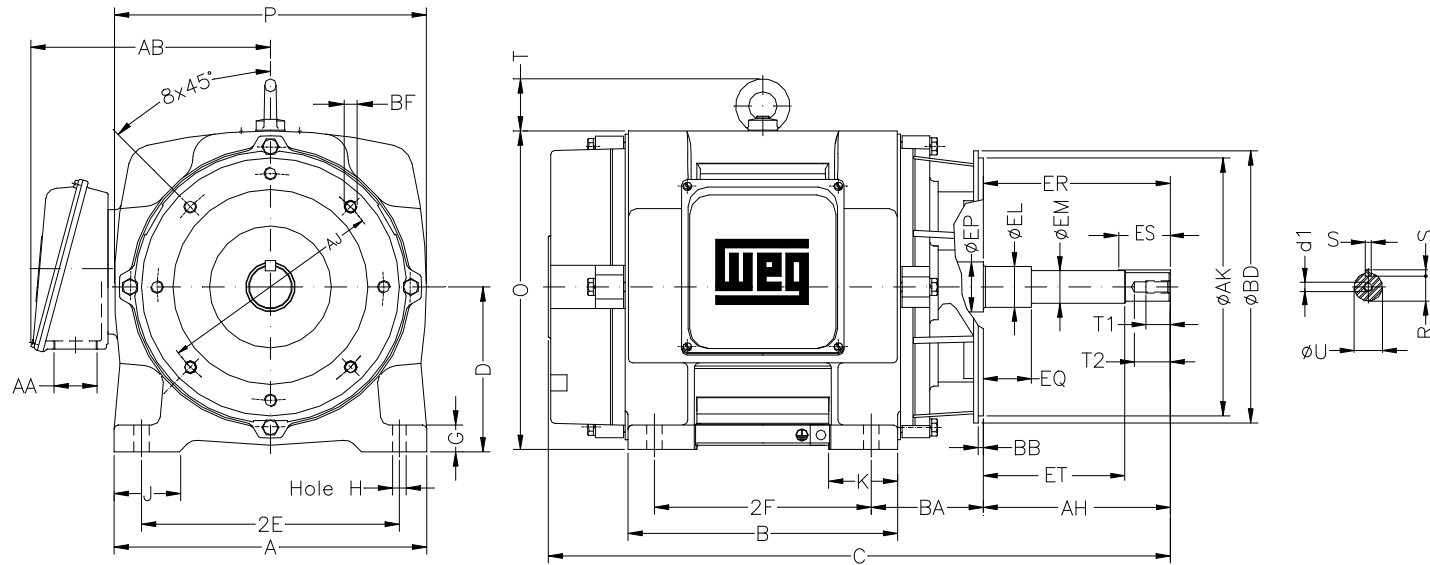

Notes: Downloaded from <http://dealerselectric.com>
Generated for Model #15036OP3G405JP

2E 16.000	A 19.950	2F 12.244/13.740	B 17.700	J 3.950
BA 6.625	D 10.000	K 5.440	G 1.968	O 19.409
P 17.874	T 2.800	H 0.807	AA NPT 3"	ER 8.130
EQ 2.382	ET 5.886	U 1.624	EM 1.750	EL 2.125
S 0.375	EP 2.754	R 1.413	ES 2.480	d1 EUNC 1/2"-13
t1 0.984	t2 1.496	C 35.263	Flange FC-279	AJ 11.000
AK 12.500	BD 14.960	BF UNC 5/8"x11	BB 0.250	AH 8.130

Performed by:

Checked:

Customer:

Close Coupled Pump : Three-Phase - "JP" Type - ODP - High Efficiency

Three-phase induction motor
Frame 405JP - IP23

28-SEP-2016

