

1 2 3 4 5 6 7 8

A

B

C

D

E

F

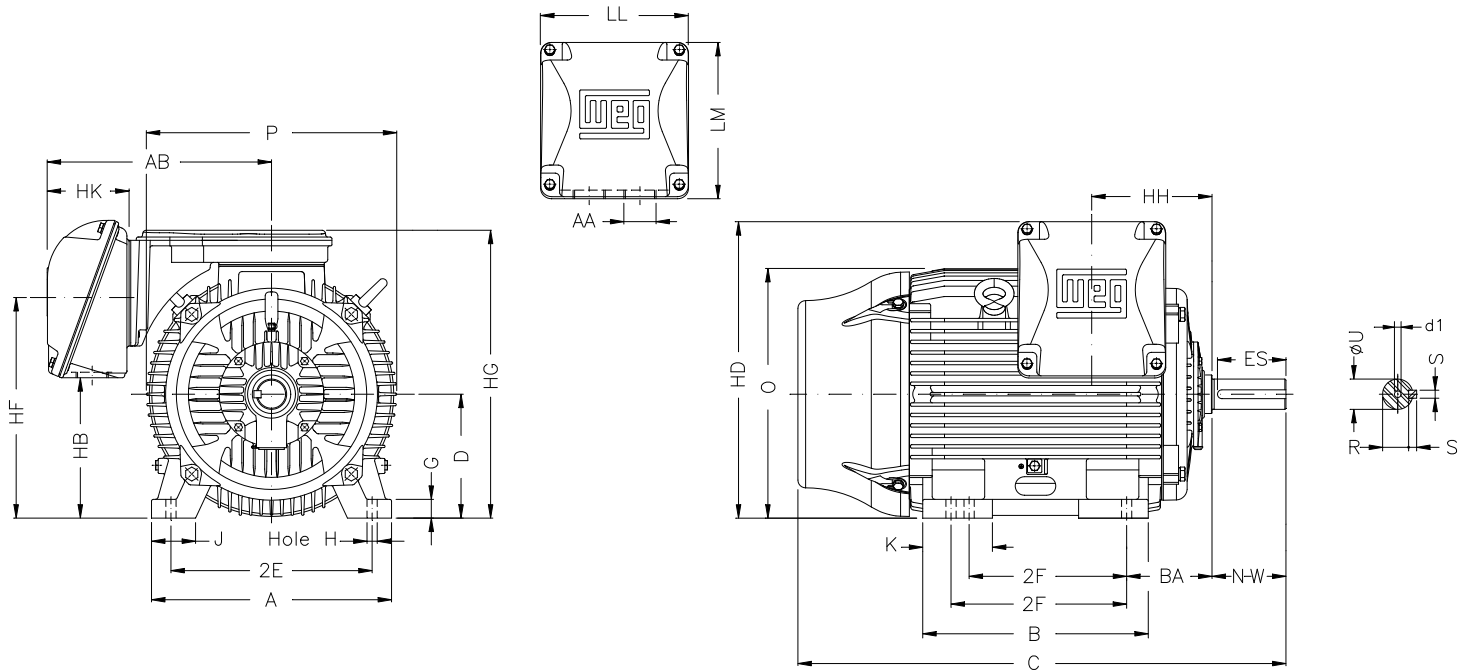

Notes: Downloaded from <http://dealerselectric.com>
Generated for Model #15012ET3HRB504T-W22

2E 20.000	J 4.724	A 24.724	P 25.866	AB 20.599
2F 16.000/18.000	K 7.228	B 24.449	BA 8.500	U 3.625
N-W 10.630	ES 8.661	S 0.875	R 3.134	depth 0.875
D 12.500	G 1.870	HB 15.167	O 25.425	HD 30.206
HF 24.291	HG 29.502	HH 10.374	HK 6.929	EV 2.756
H 1.250	C 54.095	LL 14.921	LM 15.039	AA 2xNPT 3"
d1 DUNC 3/4"-10				

Performed by:	
Checked:	
Customer:	
W22 NEMA Premium - Roller Bearings	
Three-phase induction motor Frame 504/5T - IP55	28-SEP-2016

