

1 2 3 4 5 6 7 8

A

B

C

D

E

F

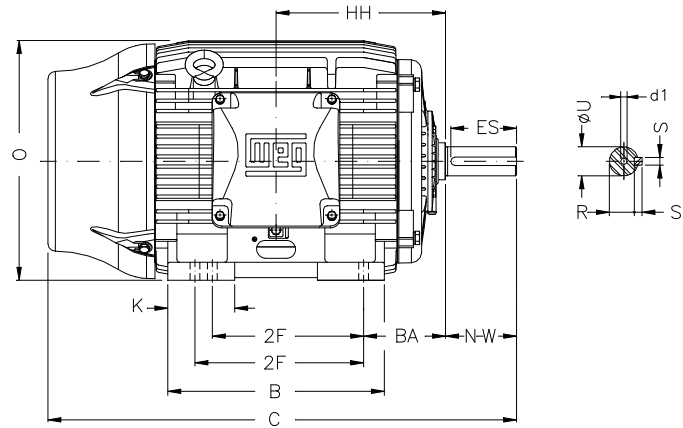

Notes: Downloaded from <http://dealerselectric.com>
Generated for Model #12512EG3G445T-W22

Performed by:

Checked:

Customer:

W22 Super Premium

Three-phase induction motor
Frame 444/5T - IP55

28-SEP-2016



2E 18.000	J 3.937	A 21.929	P 23.583	AB 18.570
2F 14.500/16.500	K 5.866	B 20.315	BA 7.500	U 3.375
N-W 8.500	ES 7.087	S 0.875	R 2.880	depth 0.875
D 11.000	G 1.630	HB 5.687	O 22.795	HH 15.748
HK 5.970	H 0.810	C 45.157	LL 12.362	LM 12.283
AA 2xNPT 3"	d1 DUNC 3/4"-10			