

1 2 3 4 5 6 7 8

A

B

C

D

E

F

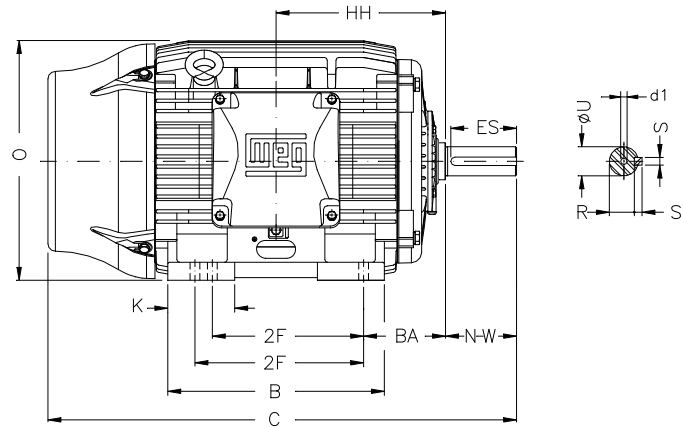
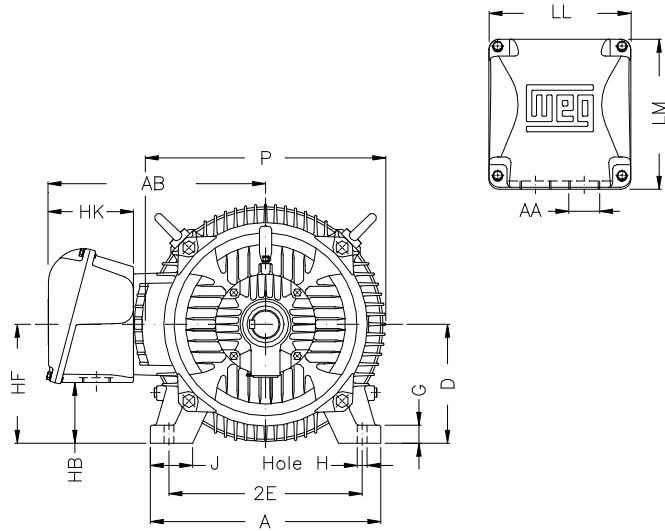

Notes: Downloaded from <http://dealerselectric.com>
Generated for Model #10036ST3QIE405TS-W22

Performed by:

Checked:

Customer:

Three-Phase: W22 IEEE-841™ Petrochem Motors - NEMA Premium® Efficiency

Three-phase induction motor
Frame 404/5TS - IP55

28-SEP-2016



2E 15.984	J 3.937	A 19.921	P 19.134	AB 16.016
2F 12.244/13.740	K 5.669	B 18.386	BA 6.625	U 2.125
N-W 4.250	ES 3.150	S 0.500	R 1.842	depth 0.500
D 10.000	G 1.811	HB 5.252	O 19.566	HH 13.496
HK 6.024	H 0.810	C 36.732	LL 10.591	LM 11.267
AA NPT 3"	d1 DUNC 3/4"-10	d2 DUNC 3/4"-10		