

1 2 3 4 5 6 7 8

A

B

C

D

E

F

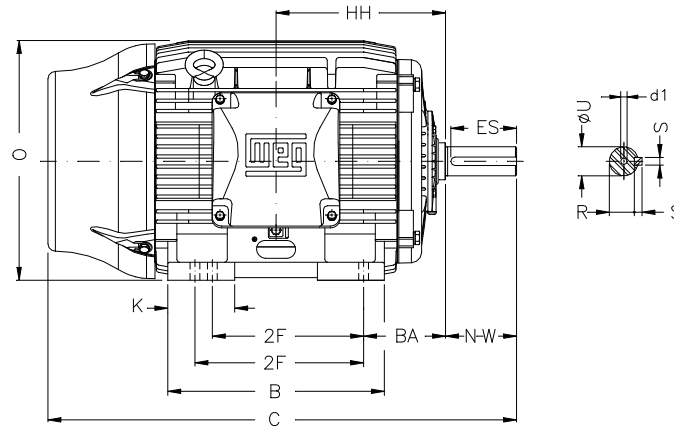

Notes: Downloaded from <http://dealerselectric.com>  
Generated for Model #10036ET3H405TS-W22

Performed by:

Checked:

Customer:

W22 NEMA Premium - Ball Bearings

Three-phase induction motor  
Frame 404/5TS - IP55

28-SEP-2016



2E 15.984	J 3.937	A 19.921	P 19.134	AB 16.016
2F 12.244/13.740	K 5.669	B 18.386	BA 6.625	FBA 13.926
U 2.125	N-W 4.250	ES 2.756	S 0.500	R 1.842
depth 0.500	D 10.000	G 1.811	HB 5.252	O 19.566
HH 13.496	HK 6.024	EV 2.323	H 0.810	C 36.732
LL 10.591	LM 11.267	AA NPT 3"	d1 DUNC 3/4"-10	