

1 2 3 4 5 6 7 8

A

B

C

D

E

F

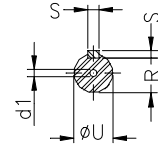
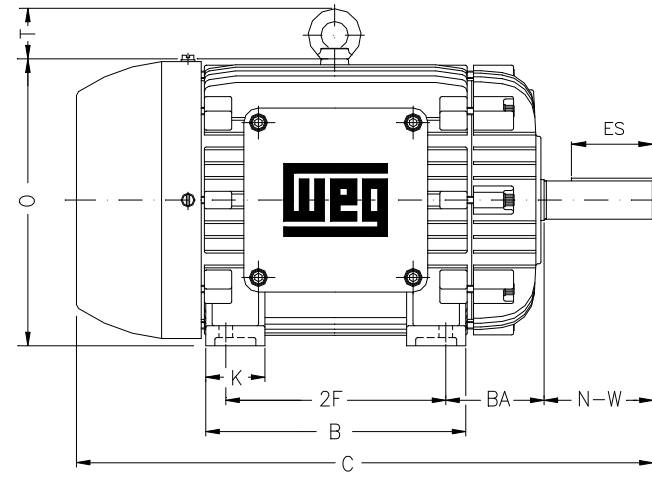
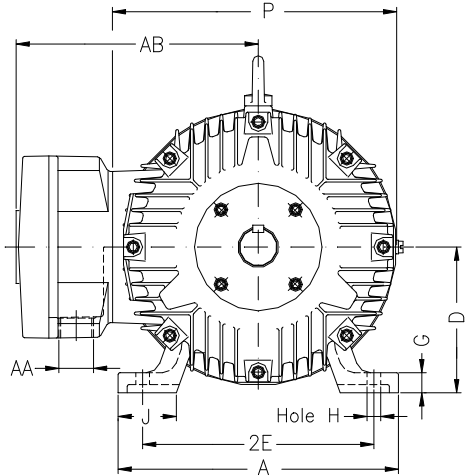

Notes: Downloaded from <http://dealerselectric.com>
Generated for Model #10012XT3E444T

Performed by:

Checked:

Customer:

Three-Phase : Explosion Proof - NEMA Premium

Three-phase induction motor
Frame 444/5T - IP55

27-SEP-2016



2E 18.000	A 21.929	2F 14.500/16.500	B 20.079	BA 7.500
J 3.937	FBA 11.769/13.769	K 5.591	P 24.016	ES 7.087
depth 0.875	S 0.875	N-W 8.500	U 3.375	R 2.880
AB 21.732	D 11.000	G 1.630	O 23.622	T 3.543
H 0.807	C 43.797	FC 50.143	AA 2xNPT 3"	d1 DUNC 3/4"-10
d2 DUNC 3/4"-10				