

1 2 3 4 5 6 7 8

A

B

C

D

E

F

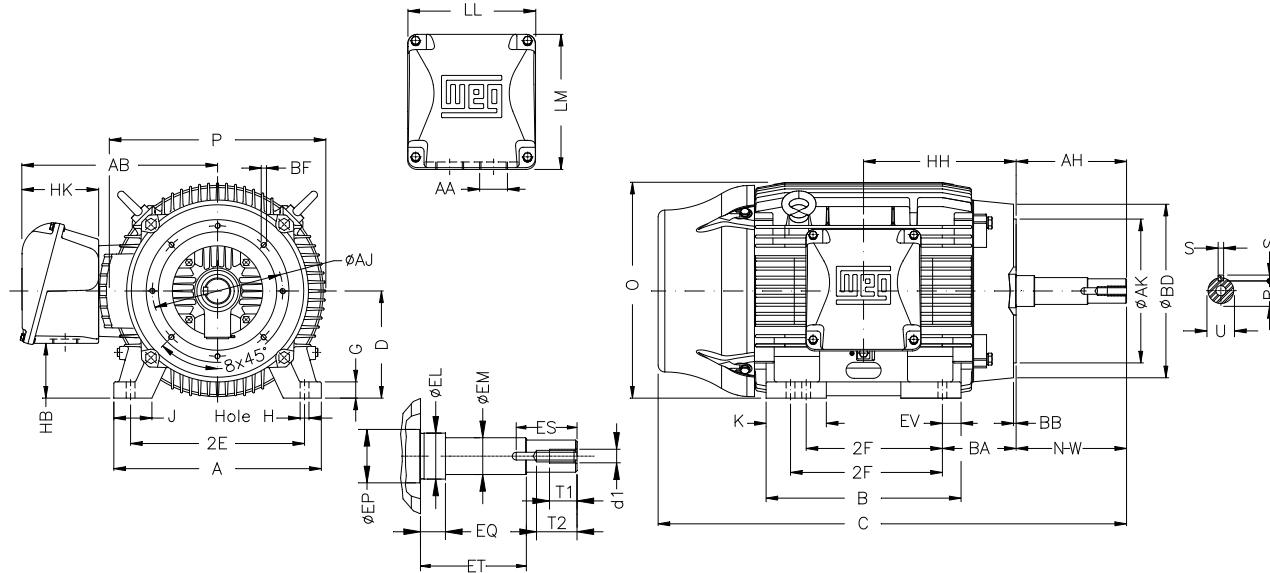

Notes: Downloaded from <http://dealerselectric.com>
Generated for Model #07536ET3H365JP-W22

2E	J	A	P	AB
14.016	3.150	17.165	17.914	16.016
2F	K	B	BA	D
11.260/12.244	4.138	16.220	5.875	9.000
G	O	H	AA	EQ
1.480	17.716	0.660	NPT 3"	2.382
ET	U	EM	EL	EP
5.886	1.624	1.750	2.125	2.756
ES	t1	t2	C	d1
2.480	0.984	1.496	36.711	EUNC 1/2"-13
HH	HK	HB	LL	LM
11.988	6.024	4.251	10.591	11.267
S	R	Flange	AJ	AK
0.375	1.413	FC-279	11.000	12.500
BD	BF	BB	AH	
15.562	UNC 5/8"x11	0.248	8.130	

Performed by:

Checked:

Customer:

Close Coupled Pump: Three-Phase - W22 "JP" Type - TEFC - NEMA Premium

Three-phase induction motor
Frame 364/5JP - IP55

27-SEP-2016

