

1 2 3 4 5 6 7 8

A

B

C

D

E

F

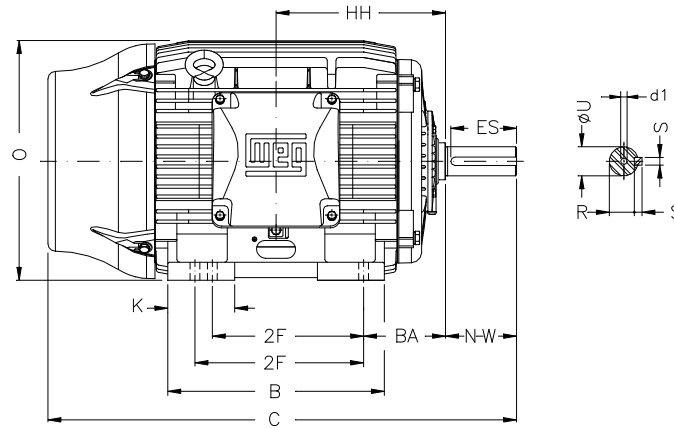
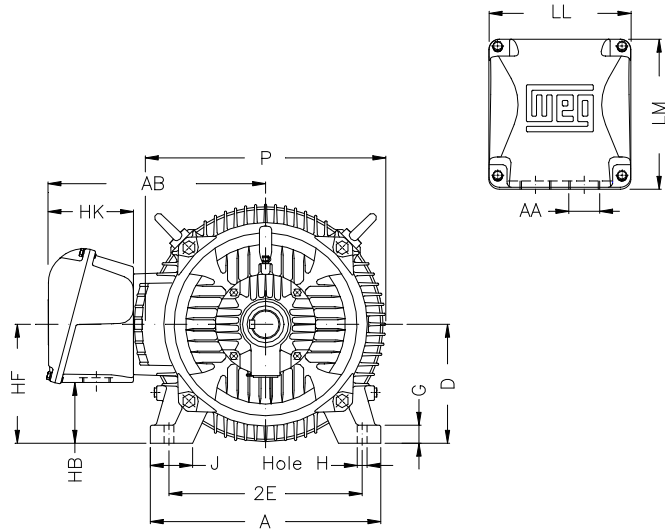

Notes: Downloaded from <http://dealerselectric.com>
Generated for Model #07518ST3QIE365T-W22

Performed by:

Checked:

Customer:

Three-Phase: W22 IEEE-841™ Petrochem Motors - NEMA Premium® Efficiency

Three-phase induction motor
Frame 364/5T - IP55

27-SEP-2016



2E 14.016	J 3.150	A 17.165	P 17.914	AB 16.016
2F 11.260/12.244	K 4.138	B 16.220	BA 5.875	U 2.375
N-W 5.874	ES 4.330	S 0.625	R 2.019	depth 0.625
D 9.000	G 1.480	HB 4.251	O 17.957	HH 11.988
HK 6.024	H 0.660	C 34.251	LL 10.591	LM 11.267
AA NPT 3"	d1 DUNC 3/4"-10	d2 DUNC 3/4"-10		