

1 2 3 4 5 6 7 8

A

B

C

D

E

F

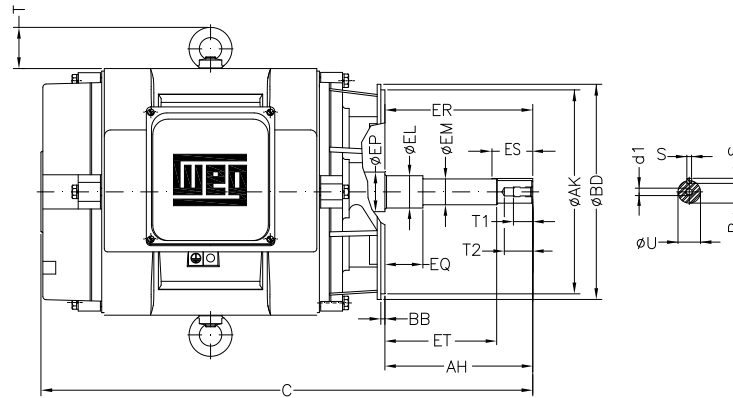
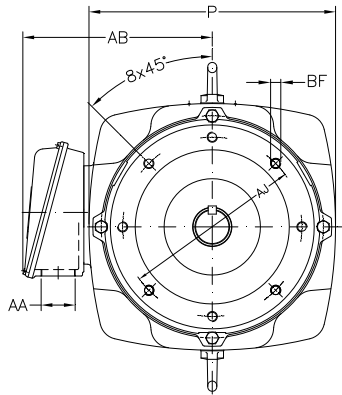

Notes: Downloaded from <http://dealerselectric.com>
Generated for Model #07518OP3E365JPV

Performed by:

Checked:

Customer:

Close Coupled Pump : Three-Phase - "JP" Type - ODP - High Efficiency

Three-phase induction motor
Frame 365JP - IP23

27-SEP-2016



P 17.874	AB 16.378	AA NPT 3"	ER 8.130	EQ 2.382
ET 5.886	U 1.624	EM 1.750	EL 2.125	S 0.375
EP 2.756	R 1.413	ES 2.480	d1 EUNC 1/2"-13	t1 0.984
t2 1.496	C 32.019	Flange FC-279	AJ 11.000	AK 12.500
BD 13.189	BF UNC 5/8"x11	BB 0.250	AH 8.130	