

1 2 3 4 5 6 7 8

A

B

C

D

E

F

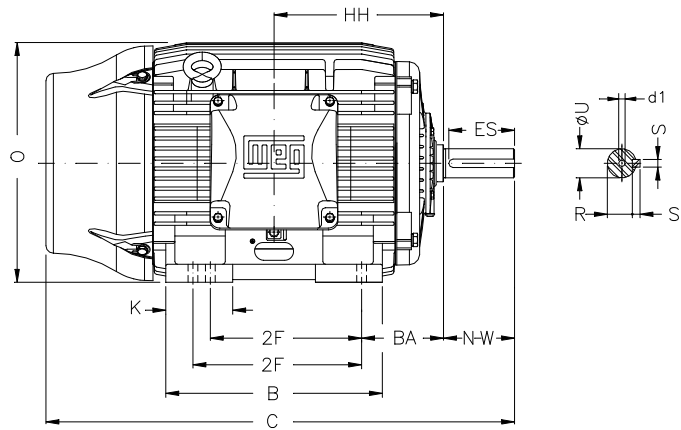
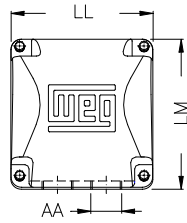

Notes: Downloaded from <http://dealerselectric.com>
Generated for Model #07518ET3G365T-W22

Performed by:

Checked:

Customer:

W22 NEMA Premium - Ball Bearings

Three-phase induction motor
Frame 364/5T - IP55

27-SEP-2016



2E 14.016	J 3.150	A 17.165	P 17.914	AB 16.016
2F 11.260/12.244	K 4.138	B 16.220	BA 5.875	FBA 11.708
U 2.375	N-W 5.874	ES 4.330	S 0.625	R 2.019
depth 0.625	D 9.000	G 1.480	HB 4.251	O 17.957
HH 11.988	HK 6.024	EV 1.634	H 0.660	C 34.251
FC 39.339	LL 10.591	LM 11.267	AA NPT 3"	d1 DUNC 3/4"-10