

1 2 3 4 5 6 7 8

A

B

C

D

E

F

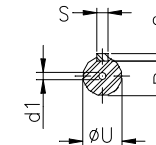
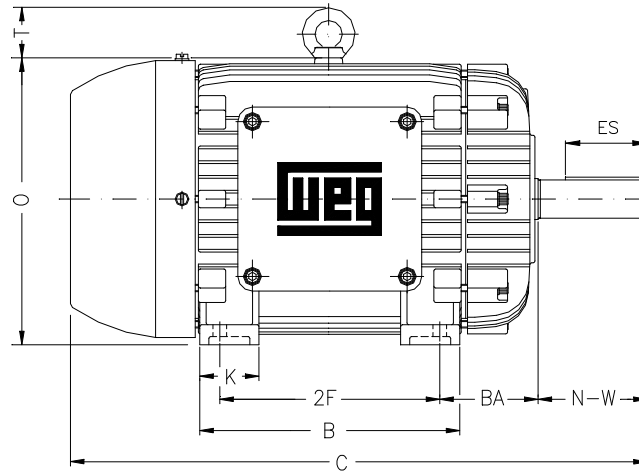

Notes: Downloaded from <http://dealerselectric.com>
Generated for Model #07512XT3E405T

Performed by:

Checked:

Customer:

Three-Phase : Explosion Proof - NEMA Premium

Three-phase induction motor
Frame 404/5T - IP55

27-SEP-2016



2E 16.000	A 19.921	2F 12.250/13.752	B 17.520	BA 6.625
J 3.937	K 5.433	P 18.583	ES 5.512	depth 0.750
S 0.750	N-W 7.250	U 2.875	R 2.449	AB 16.654
D 10.000	G 1.812	O 19.843	T 2.795	H 0.807
C 38.074	AA NPT 3"	d1 DUNC 3/4"-10	d2 DUNC 3/4"-10	