

1 2 3 4 5 6 7 8

A

B

C

D

E

F

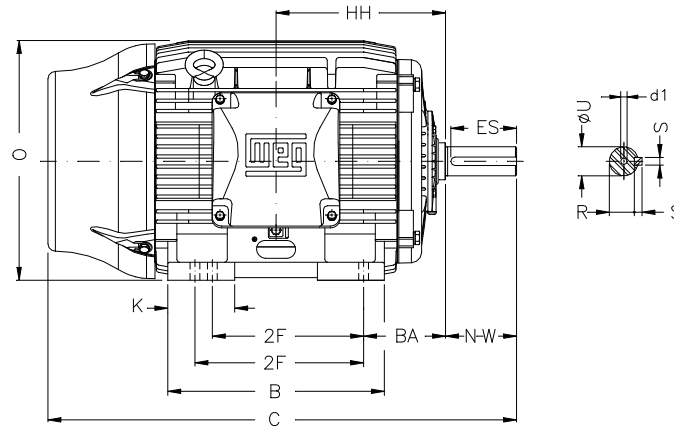

Notes: Downloaded from <http://dealerselectric.com>  
Generated for Model #06036EG3E364TS-W22

Performed by:

Checked:

Customer:

W22 Super Premium

Three-phase induction motor  
Frame 364/5TS - IP55

27-SEP-2016



2E 14.016	J 3.150	A 17.165	P 17.914	AB 16.016
2F 11.260/12.244	K 4.138	B 16.220	BA 5.875	FBA 11.708
U 1.875	N-W 3.748	ES 1.968	S 0.500	R 1.591
depth 0.500	D 9.000	G 1.480	HB 4.251	O 17.957
HH 11.988	HK 6.024	H 0.660	C 32.338	LL 10.591
LM 11.267	AA NPT 3"	d1 DUNC 3/4"-10		