

1 2 3 4 5 6 7 8

A

B

C

D

E

F

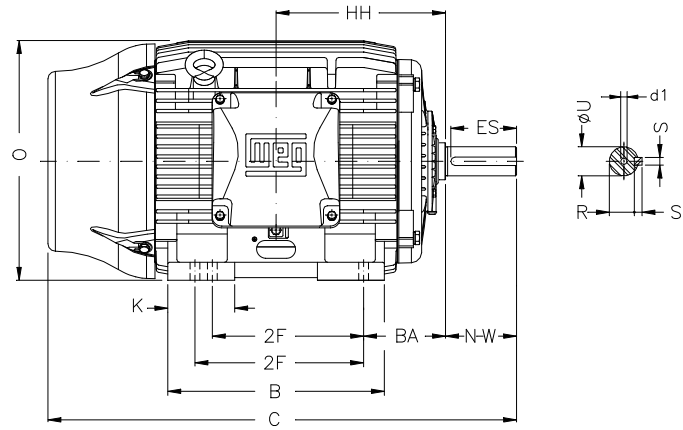

Notes: Downloaded from <http://dealerselectric.com>
Generated for Model #06009ET3E405T-W22

Performed by:

Checked:

Customer:

W22 NEMA Premium - Ball Bearings

Three-phase induction motor
Frame 404/5T - IP55

27-SEP-2016



2E 15.984	J 3.937	A 19.921	P 19.134	AB 16.016
2F 12.244/13.740	K 5.669	B 18.386	BA 6.625	FBA 13.926
U 2.875	N-W 7.250	ES 5.512	S 0.750	R 2.449
depth 0.750	D 10.000	G 1.811	HB 5.252	O 19.566
HH 13.496	HK 6.024	EV 2.323	H 0.810	C 39.730
FC 45.295	LL 10.591	LM 11.267	AA NPT 3"	d1 DUNC 3/4"-10