

1 2 3 4 5 6 7 8

A

B

C

D

E

F

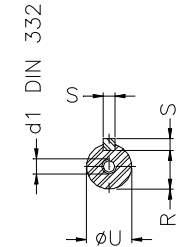
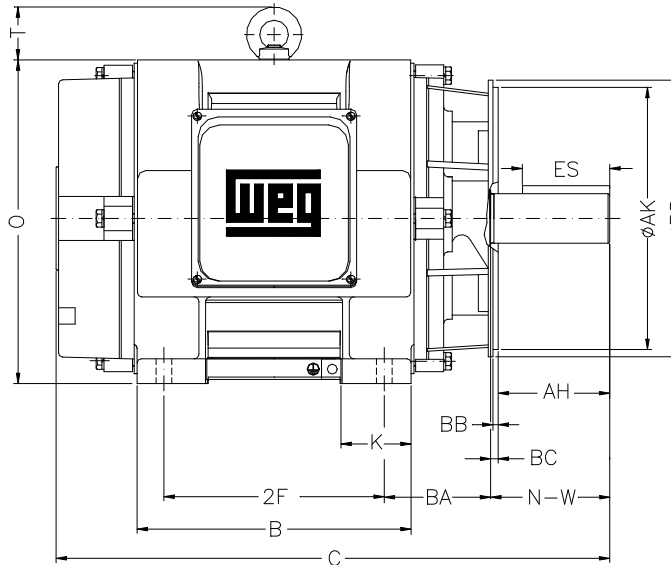
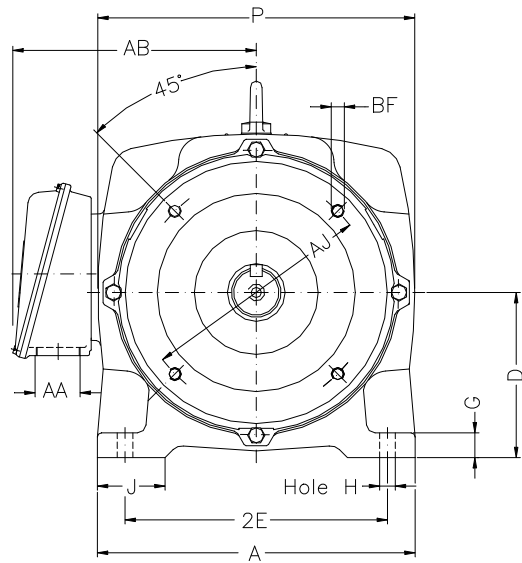

Notes: Downloaded from <http://dealerselectric.com>
Generated for Model #05036OP3EFP324TSC

2E 12.500	A 15.160	2F 10.500	B 13.070	BA 5.250
J 3.230	K 3.350	P 15.118	ES 2.756	depth 0.500
S 0.500	D 8.000	N-W 3.750	G 1.299	U 1.875
O 15.551	T 2.559	R 1.594	H 0.656	AB 11.496
C 24.685	AA NPT 2"	d1 A 4	Flange FC-279	AJ 11.000
AK 12.500	BD 15.562	BF UNC 5/8"x11	BB 0.250	BC 0.250
AH 3.500				

Performed by:	
Checked:	
Customer:	
Fire Pump Motors - ODP Three Phase - Foot Mount and Flange Mount	
Three-phase induction motor Frame 324TS - IP23	24-SEP-2016

