

1 2 3 4 5 6 7 8

A

B

C

D

E

F

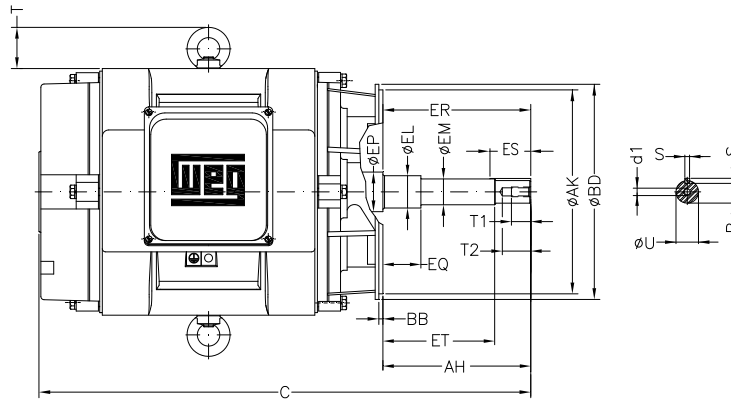
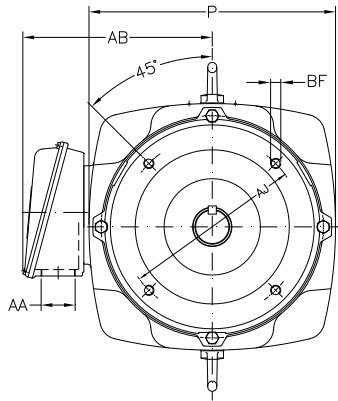

Notes: Downloaded from <http://dealerselectric.com>
Generated for Model #05018OP3E326JPV

Performed by:

Checked:

Customer:

Close Coupled Pump : Three-Phase - "JP" Type - ODP - High Efficiency

Three-phase induction motor
Frame 326JP - IP23

23-SEP-2016



P 15.118	AB 11.496	AA NPT 2"	ER 8.130	EQ 2.382
ET 5.886	U 1.249	EM 1.375	EL 1.750	S 0.250
EP 2.360	R 1.110	ES 2.559	d1 EUNC 1/2"-13	t1 0.984
t2 1.102	C 30.807	Flange FC-279	AJ 11.000	AK 12.500
BD 13.189	BF UNC 5/8"x11	BB 0.250	AH 8.130	