

1 2 3 4 5 6 7 8

A
B
C
D
E
F

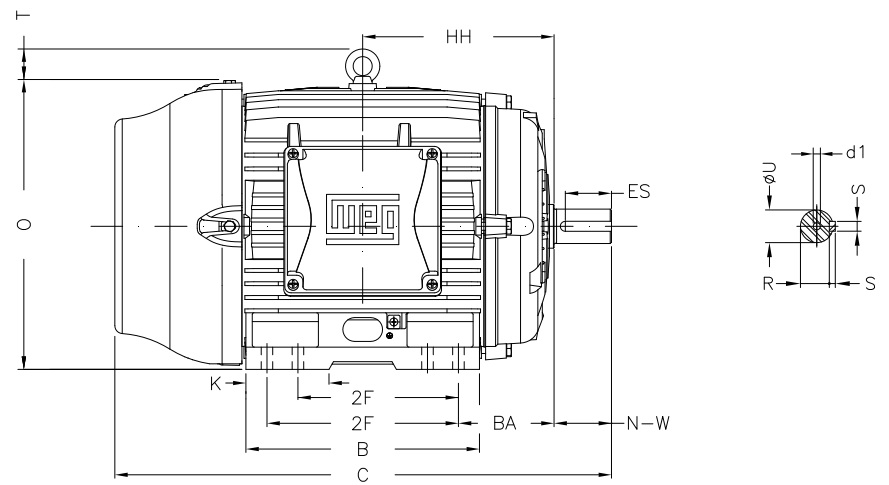
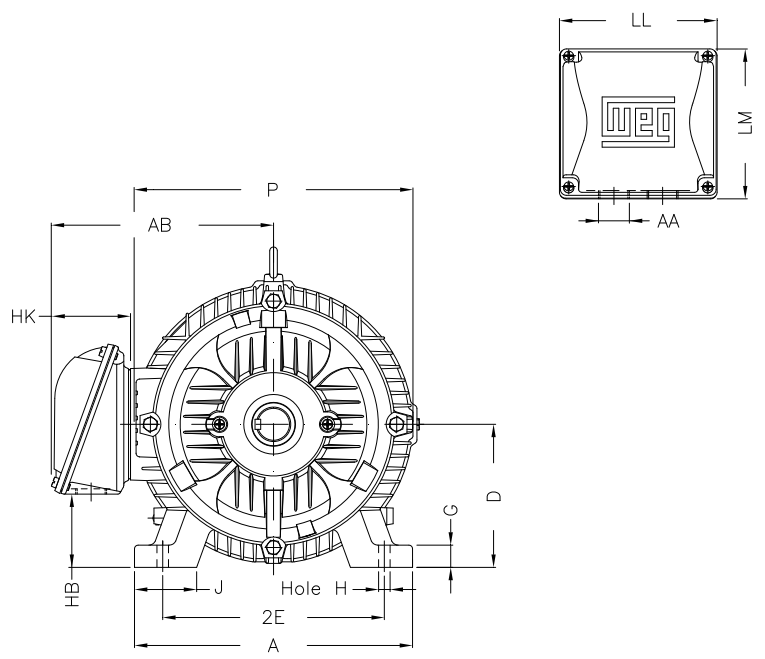

Notes: Downloaded from <http://dealerselectric.com>
Generated for Model #05018EG3E326T-W22

2E 12.500	J 3.189	A 15.157	P 15.827	AB 12.575
2F 10.500/12.000	K 4.055	B 14.567	BA 5.250	FBA 8.738
U 2.125	N-W 5.250	ES 3.937	S 0.500	R 1.844
depth 0.500	D 8.000	G 1.300	HB 4.811	O 15.953
T 2.441	HF 8.708	HH 11.250	HK 4.705	H 0.657
C 31.116	FC 35.860	LL 9.055	LM 8.661	AA NPT 2"
d1 A 4				

Performed by:
Checked:
Customer:
W22 Super Premium
Three-phase induction motor
Frame 324/6T - IP55
23-SEP-2016

