

1 2 3 4 5 6 7 8

A

B

C

D

E

F

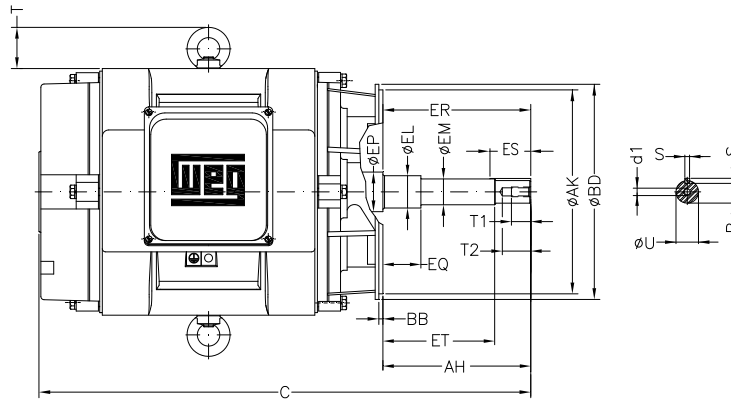
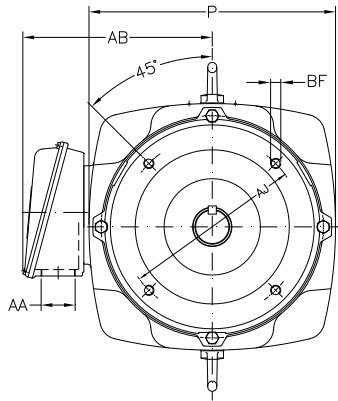

Notes: Downloaded from <http://dealerselectric.com>  
Generated for Model #04036OP3E286JPV

Performed by:

Checked:

Customer:

Close Coupled Pump : Three-Phase - "JP" Type - ODP - High Efficiency - Vertical

Three-phase induction motor  
Frame 286JP - IP23

23-SEP-2016



P 13.700	AB 10.866	AA NPT 1 1/2"	ER 8.130	EQ 2.382
ET 5.886	U 1.249	EM 1.375	EL 1.750	S 0.250
EP 2.163	R 1.110	ES 2.559	d1 EUNC 1/2"-13	t1 0.984
t2 1.496	C 28.634	Flange FC-279	AJ 11.000	AK 12.500
BD 14.000	BF UNC 5/8"x11	BB 0.250	AH 8.130	