

1 2 3 4 5 6 7 8

A

B

C

D

E

F

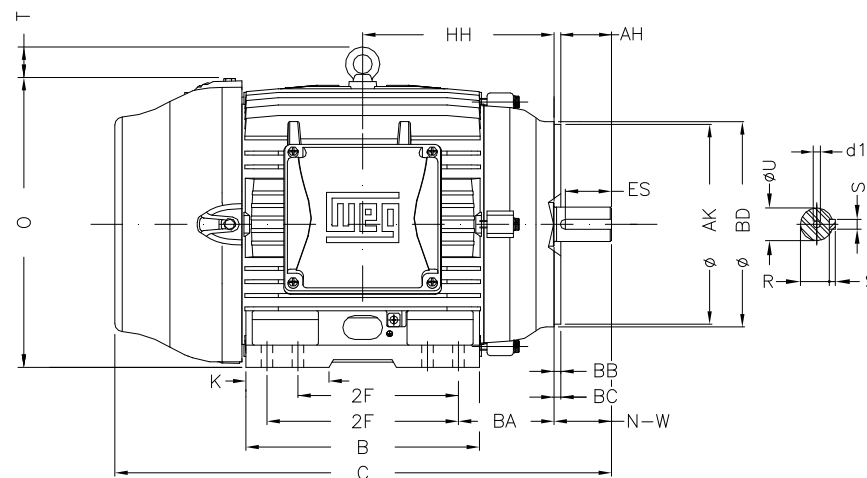
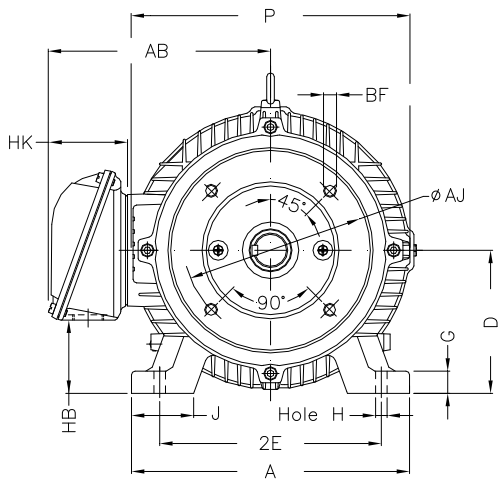
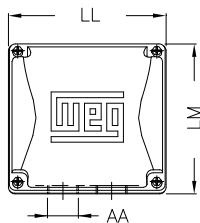

Notes: Downloaded from <http://dealerselectric.com>  
Generated for Model #04018ST3QIE324TC-W22

Performed by:

Checked:

Customer:

Three-Phase: W22 IEEE-841™ Petrochem Motors - NEMA Premium® Efficiency

Three-phase induction motor  
Frame 324/6T - IP55

23-SEP-2016



2E 12.500	J 3.189	A 15.157	P 15.827	AB 12.575
2F 10.500/12.000	K 4.055	B 14.567	BA 5.250	U 2.125
N-W 5.250	ES 3.937	S 0.500	R 1.844	depth 0.500
D 8.000	G 1.300	HB 4.811	O 15.953	T 2.441
HF 8.708	HH 11.250	HK 4.705	H 0.657	C 31.116
LL 9.055	LM 8.661	AA NPT 2"	d1 A 4	d2 A 4
Flange FC-279	AJ 11.000	AK 12.500	BD 13.58	BF UNC 5/8"x11
BB 0.250	BC 0.250	AH 5.000		