

1 2 3 4 5 6 7 8

A

B

C

D

E

F

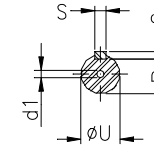
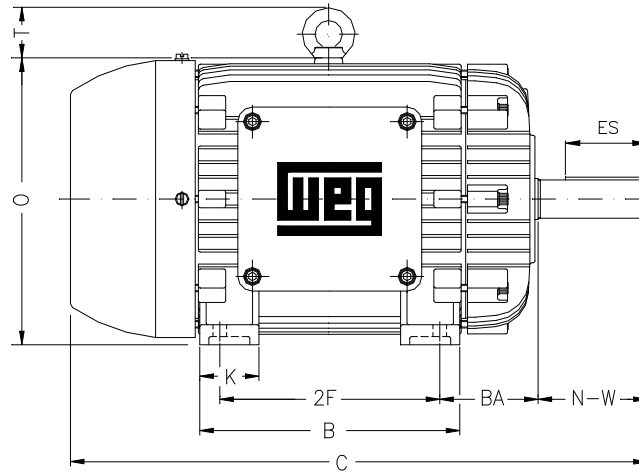
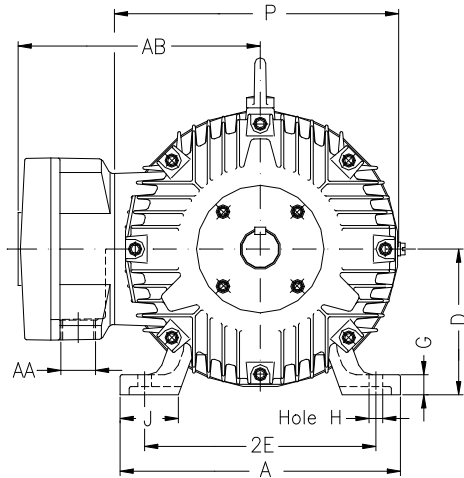

Notes: Downloaded from <http://dealerselectric.com>
Generated for Model #04009XP3E365T

Performed by:

Checked:

Customer:

Three-Phase : Explosion Proof - High Efficiency

Three-phase induction motor
Frame 365T - IP54

23-SEP-2016



2E 14.000	A 17.165	2F 11.250/12.250	B 15.394	BA 5.875
J 3.150	K 4.134	P 18.583	ES 4.330	depth 0.625
S 0.625	N-W 5.874	U 2.375	R 2.019	AB 16.654
D 9.000	G 1.480	O 18.898	H 0.657	C 33.701
AA NPT 3"	d1 DUNC 3/4"-10	d2 DUNC 3/4"-10	T 2.795	