

1 2 3 4 5 6 7 8

A

B

C

D

E

F

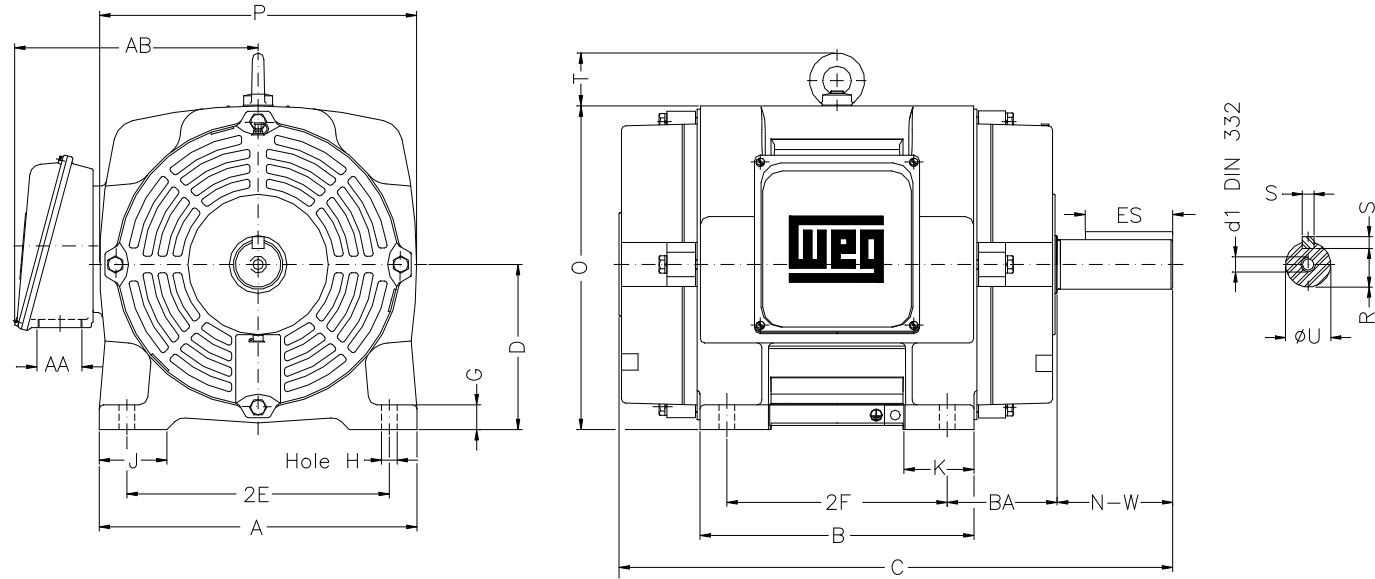

Notes: Downloaded from <http://dealerselectric.com>
Generated for Model #03036OP3HFP284TS

Performed by:

Checked:

Customer:

Fire Pump Motors - ODP Three Phase - Foot Mount and Flange Mount

2E 11.000	A 13.780	2F 9.500	B 11.574	BA 4.750
J 3.150	K 2.960	P 13.700	ES 2.480	depth 0.375
S 0.375	D 7.000	N-W 3.250	G 1.102	U 1.625
O 13.858	T 2.165	R 1.416	H 0.531	AB 10.886
C 22.000	AA NPT 1 1/2"	d1 A 4		

Three-phase induction motor
Frame 284TS - IP23

23-SEP-2016

