

1 2 3 4 5 6 7 8

A
B
C
D
E
F

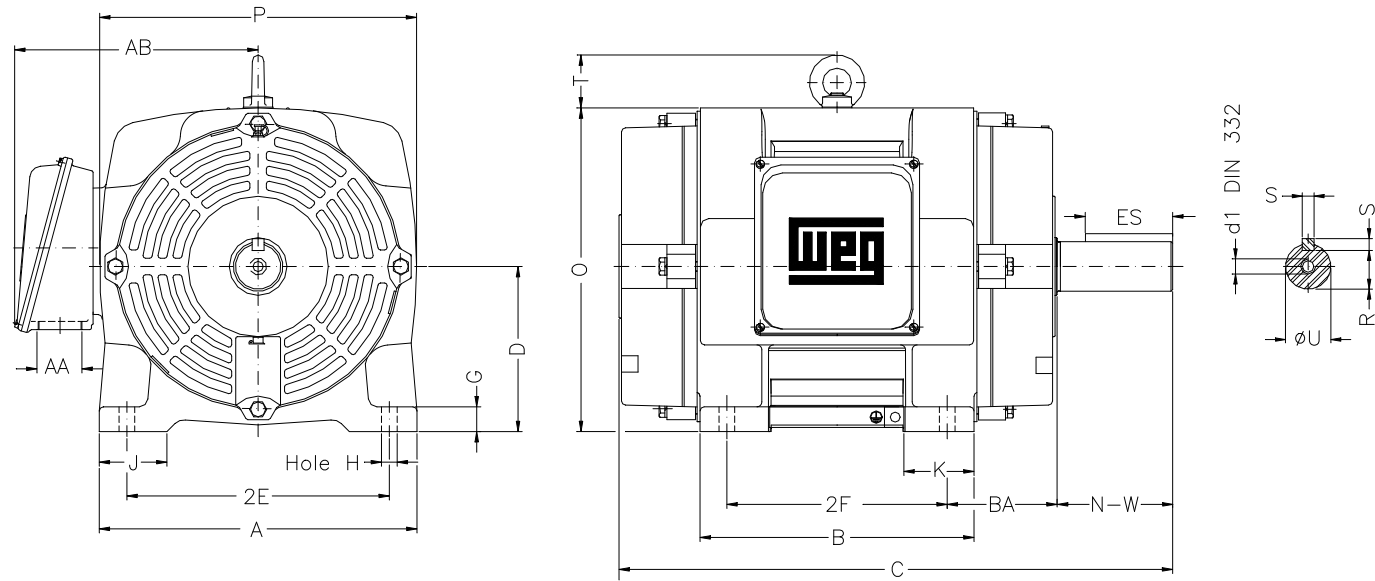

Notes: Downloaded from <http://dealerselectric.com>
Generated for Model #030180T3E286T

Performed by:

Checked:

Customer:

ODP – Open Induction Motors – NEMA Premium Efficiency

2E 11.000	J 3.150	A 13.780	P 13.700	AB 10.886
2F 11.000	K 2.960	B 13.070	BA 4.750	U 1.875
d1 A 4	N-W 4.622	ES 3.149	S 0.500	R 1.594
depth 0.500	D 7.000	G 1.102	O 13.858	T 2.165
H 0.531	C 24.882	AA NPT 1 1/2"		

Three-phase induction motor
Frame 286T - IP23

23-SEP-2016

