

1 2 3 4 5 6 7 8

A

B

C

D

E

F

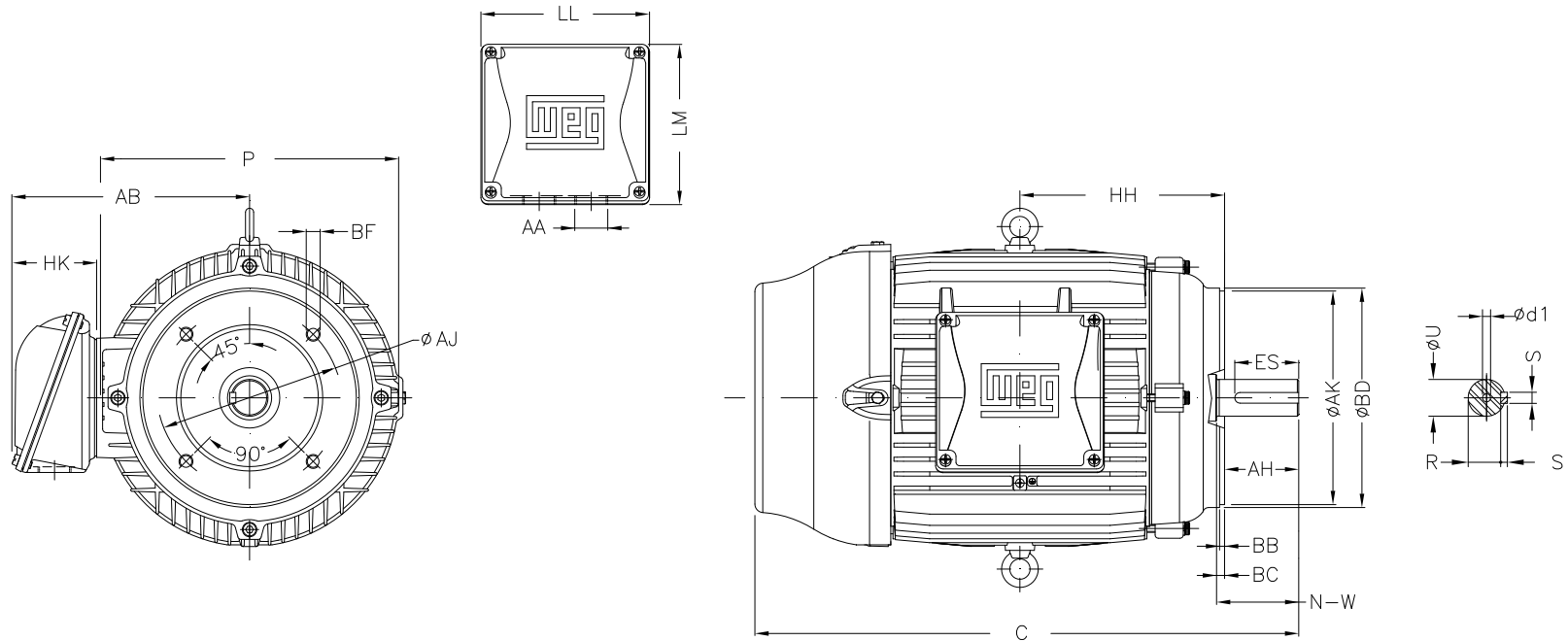

Notes: Downloaded from <http://dealerselectric.com>  
Generated for Model #03018EP3ER286TC-W22

Performed by:

Checked:

Customer:

W22 High Efficiency

Three-phase induction motor  
Frame 286T - IP55

23-SEP-2016



P	AB	U	N-W	ES
14.173	11.073	1.875	4.622	3.149
S	R	depth	HH	HK
0.500	1.594	0.500	10.250	3.976
C	LL	LM	AA	d1
27.929	7.815	7.480	NPT 1 1/2"	A 4
Flange	AJ	AK	BD	BF
FC-228	9.000	10.500	11.03	UNC 1/2"x13
BB	BC	AH		
0.250	0.250	4.375		