

1 2 3 4 5 6 7 8

A

B

C

D

E

F

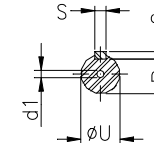
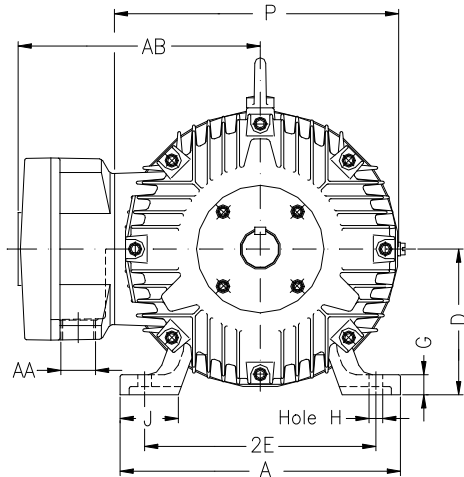

Notes: Downloaded from <http://dealerselectric.com>
Generated for Model #03012XT3E326T

Performed by:

Checked:

Customer:

Three-Phase : Explosion Proof - NEMA Premium

Three-phase induction motor
Frame 326T - IP55

23-SEP-2016



2E 12.500	A 15.157	2F 12.000	B 14.567	BA 5.250
J 3.228	K 3.346	P 15.697	ES 3.937	depth 0.500
S 0.500	N-W 5.250	U 2.125	R 1.844	AB 12.961
D 8.000	G 1.307	O 15.992	T 2.795	H 0.657
C 31.106	AA NPT 2"	d1 A 4	d2 A 4	