

1 2 3 4 5 6 7 8

A

B

C

D

E

F

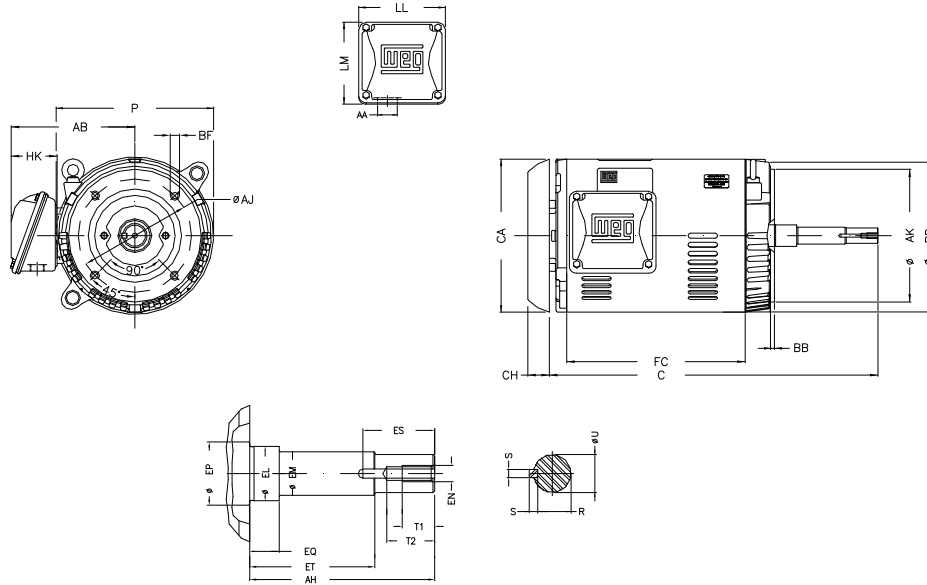

Notes: Downloaded from <http://dealerselectric.com>
Generated for Model #02536OT3H256JMV-S

Performed by:

Checked:

Customer:

Close Coupled Pump: Three-Phase - W01 (Rolled Steel) "JM" Type - ODP -

P	AB	AA	ER	EQ
11.558	9.448	1.732"	5.250	0.630
ET	U	EM	EL	EP
3.006	1.249	1.375	1.750	1.769
ES	t1	t2	C	FC
2.559	1.024	1.496	21.969	12.992
Flange	AJ	AK	BD	BF
FC-184	7.250	8.500	11.084	UNC 1/2"x13
BB	AH			
0.250	5.250			

Three-phase induction motor
Frame 254/6JM - ODP

23-SEP-2016

