

1 2 3 4 5 6 7 8

A
B
C
D
E
F

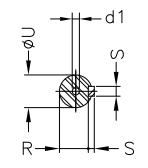
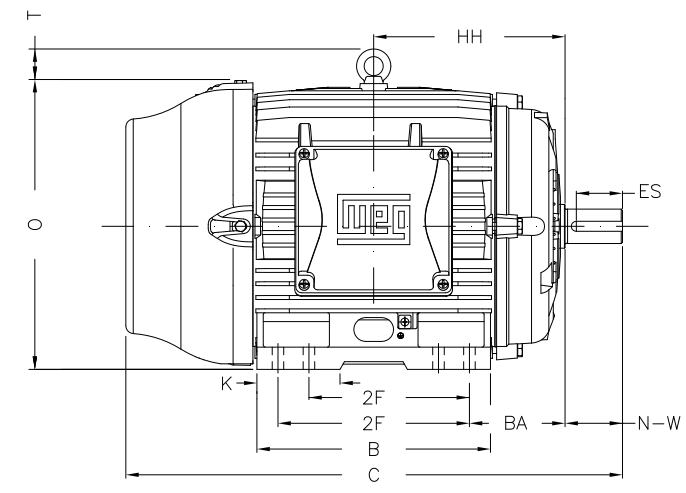
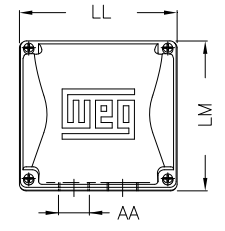
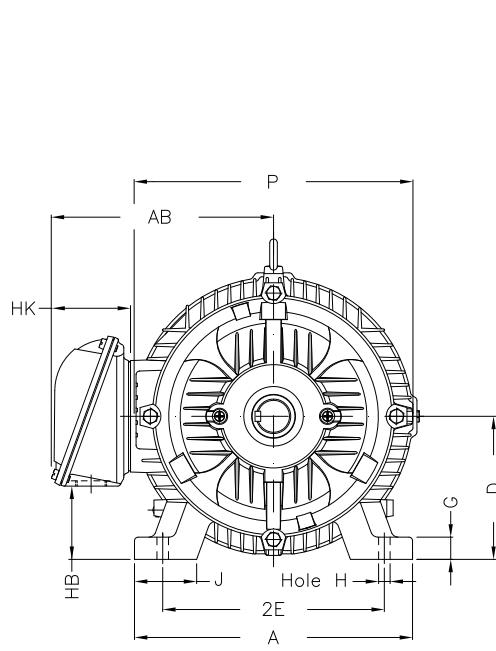

Notes: Downloaded from <http://dealerselectric.com>
Generated for Model #02536ET3E284TS-W22

Performed by:

Checked:

Customer:

W22 NEMA Premium - Ball Bearings

Three-phase induction motor
Frame 284/6TS - IP55

23-SEP-2016



2E 11.000	J 3.071	A 13.780	P 14.173	AB 11.073
2F 9.500/11.000	K 3.583	B 13.071	BA 4.750	FBA 7.876
U 1.625	N-W 3.250	ES 2.480	S 0.375	R 1.416
depth 0.375	D 7.000	G 1.023	HB 3.535	O 14.067
T 2.087	HF 7.000	HH 10.250	HK 3.976	H 0.531
C 26.557	LL 7.815	LM 7.480	AA NPT 1 1/2"	d1 A 4