

1 2 3 4 5 6 7 8

A
B
C
D
E
F

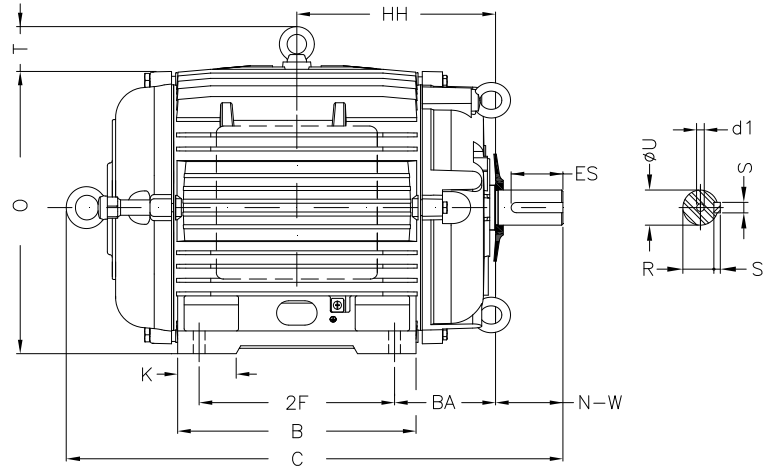
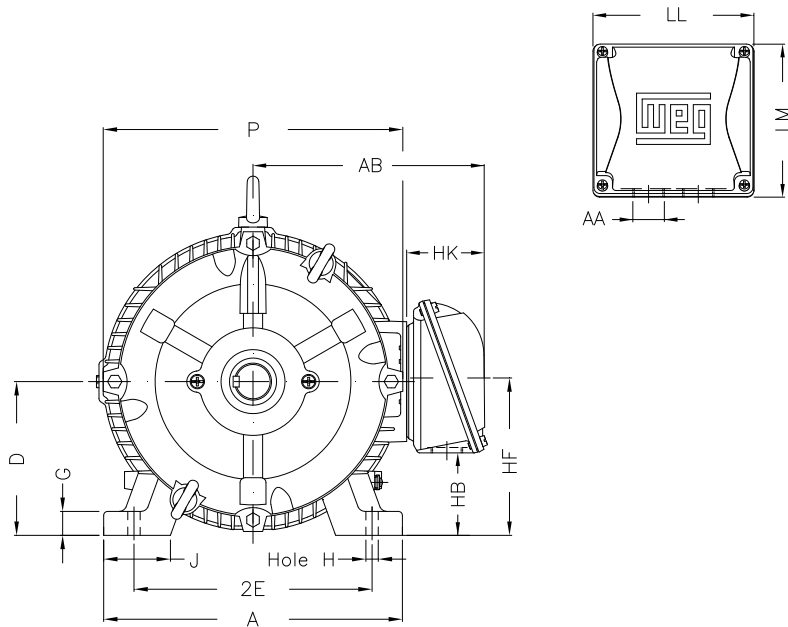

Notes: Downloaded from <http://dealerselectric.com>
Generated for Model #02518AT3ECT284T-W22

Performed by:

Checked:

Customer:

W22 Cooling Tower Motors: NEMA Premium - TEAO

2E 11.000	J 3.071	A 13.780	P 13.780	AB 11.073
2F 9.500	K 3.583	B 11.575	BA 4.750	U 1.875
N-W 4.622	ES 3.149	S 0.500	R 1.594	depth 0.500
D 7.000	G 1.023	HB 3.535	O 14.067	T 2.087
HF 7.000	HH 9.500	HK 3.976	H 0.531	C 25.418
LL 7.815	LM 7.480	AA NPT 1 1/2"	d1 A 4	

Three-phase induction motor
Frame 284T - IP55

23-SEP-2016

