

1 2 3 4 5 6 7 8

A

B

C

D

E

F

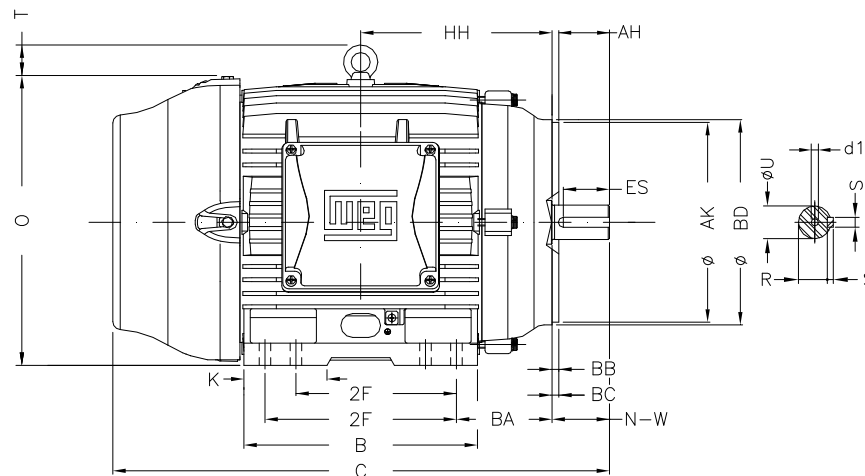
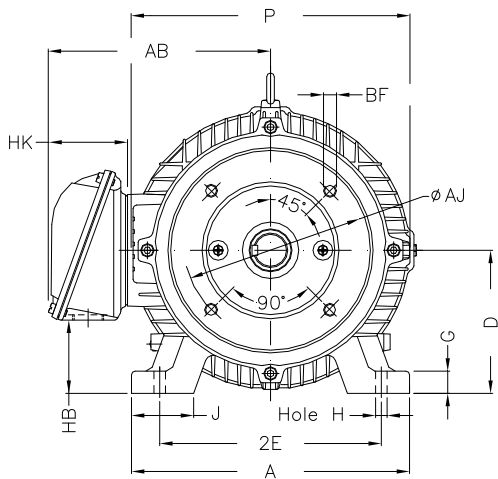
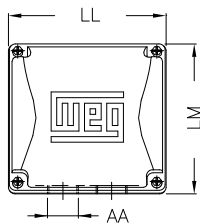

Notes: Downloaded from <http://dealerselectric.com>
Generated for Model #02036ET3H256TC-W22

Performed by:

Checked:

Customer:

W22 NEMA Premium - Ball Bearings

Three-phase induction motor
Frame 254/6T - IP55

23-SEP-2016



2E	J	A	P	AB
10.000	2.539	12.126	12.953	10.483
2F	K	B	BA	FBA
8.252/10.000	2.559	11.732	4.250	6.852
U	N-W	ES	S	R
1.625	4.000	2.756	0.375	1.416
depth	D	G	HB	O
0.375	6.250	0.827	3.061	12.598
T	HF	HH	HK	H
2.087	6.565	9.250	3.976	0.531
C	LL	LM	AA	d1
24.945	7.815	7.480	NPT 1 1/2"	A 4
Flange	AJ	AK	BD	BF
FC-184	7.250	8.500	8.875	UNC 1/2"x13
BB	BC	AH		
0.250	0.250	3.750		