

1 2 3 4 5 6 7 8

A  
B  
C  
D  
E  
F

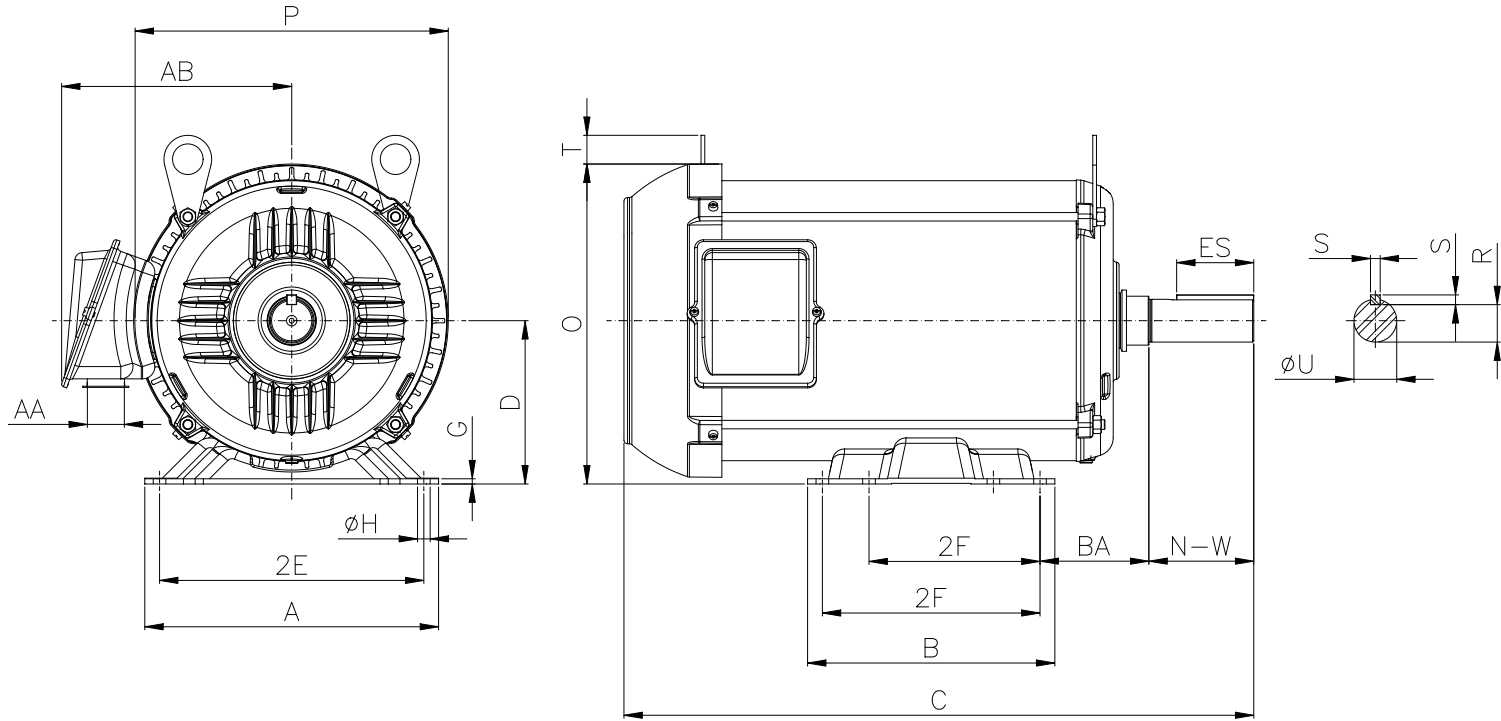

Notes: Downloaded from <http://dealerselectric.com>  
Generated for Model #02036ET3ERS256T

Performed by:

Checked:

Customer:

Three-Phase : Rolled Steel Motor - NEMA Premium Efficiency

2E 10.000	A 12.126	P 11.181	AB 7.819	2F 8.252/10.000
B 11.417	BA 4.250	U 1.625	N-W 4.000	ES 2.756
S 0.375	R 1.416	depth 0.375	D 6.250	G 0.187
O 11.841	T 0.688	H 0.531	C 24.925	d1 A 4
d2 A 4				

Three-phase induction motor  
Frame 256T - IP55

23-SEP-2016

