

1 2 3 4 5 6 7 8

A

B

C

D

E

F

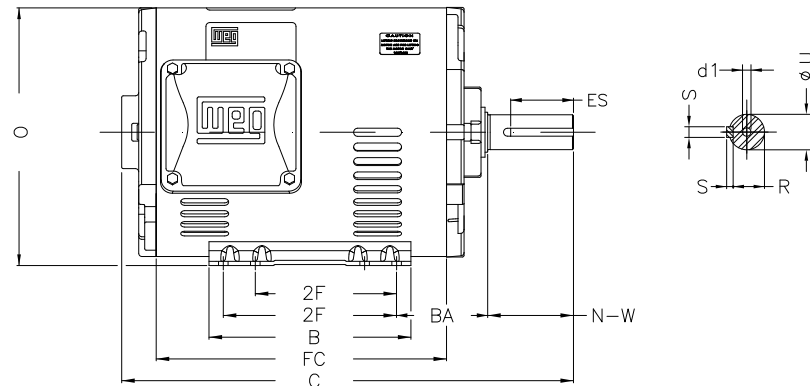
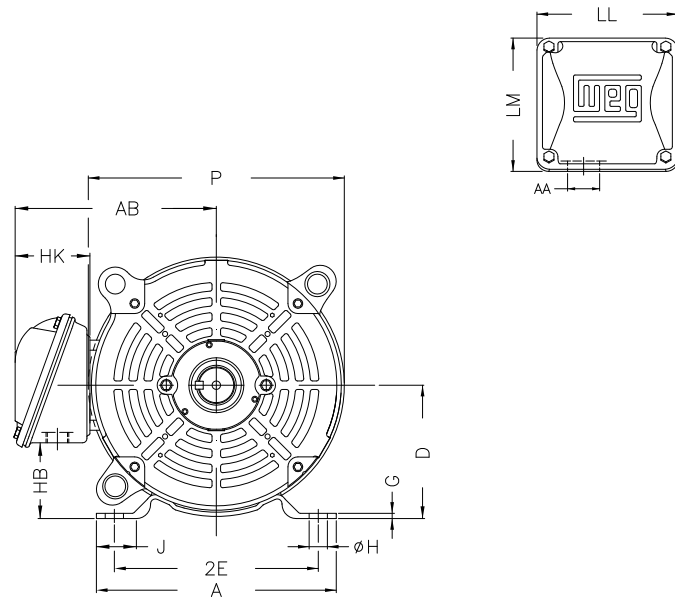

Notes: Downloaded from <http://dealerselectric.com>
Generated for Model #02018OP3EFP256T-S

Performed by:

Checked:

Customer:

Fire Pump: Three Phase - W01 (Rolled Steel) - ODP - High Efficiency

Three-phase induction motor
Frame 254/6T - ODP

23-SEP-2016



P	AB	J	2E	A
11.558	9.448	1.693	10.000	11.417
H	G	HB	HK	T
0.530	0.187	3.631	3.645	0.019
O	FC	2F	B	C
12.010	12.992	8.252/10.000	11.417	20.472
BA	N-W	ES	d1	S
4.250	3.380	2.756	A4	0.375
U	AA	depth	R	LL
1.625	1.732"	0.375	1.416	6.299
LM	BB	D	CH	
6.017	0.019	6.250	1.929	