

1 2 3 4 5 6 7 8

A  
B  
C  
D  
E  
F

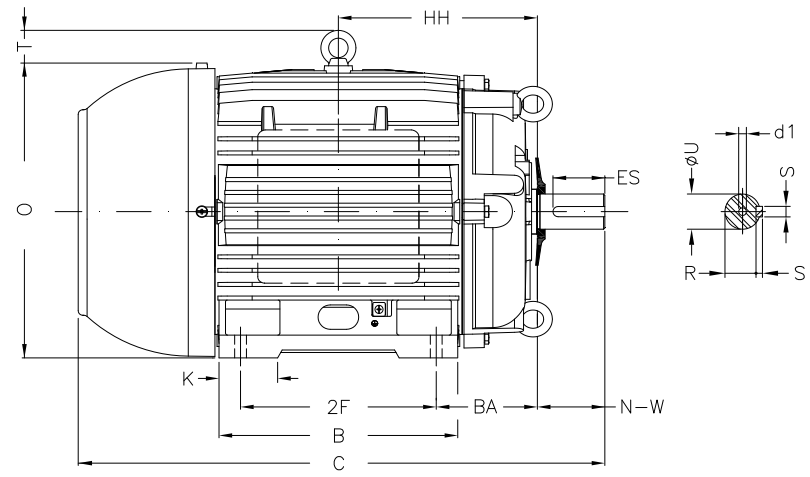
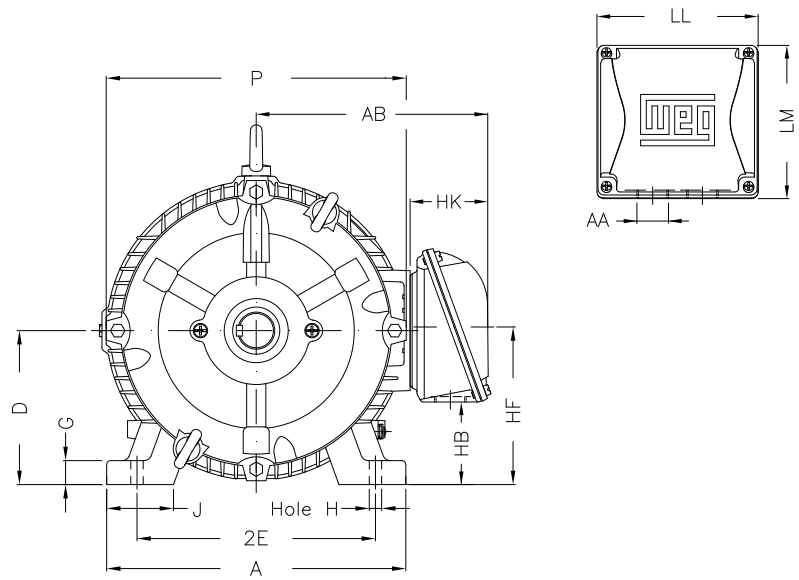

Notes: Downloaded from <http://dealerselectric.com>  
Generated for Model #02018ET3HCT256T-W22

Performed by:

Checked:

Customer:

W22 Cooling Tower Motors: NEMA Premium - TEFC

Three-phase induction motor  
Frame 256T - IP55

23-SEP-2016



2E 10.000	J 2.539	A 12.126	P 12.480	AB 10.483
2F 10.000	K 2.559	B 11.732	BA 4.250	U 1.625
N-W 4.000	ES 2.756	S 0.375	R 1.406	depth 0.375
D 6.250	G 0.827	HB 3.061	O 12.598	T 2.087
HF 6.565	HH 9.250	HK 3.987	H 0.531	C 24.945
LL 7.813	LM 7.482	AA NPT 1 1/2"	d1 A 4	d2 A 4