

1 2 3 4 5 6 7 8

A
B
C
D
E
F

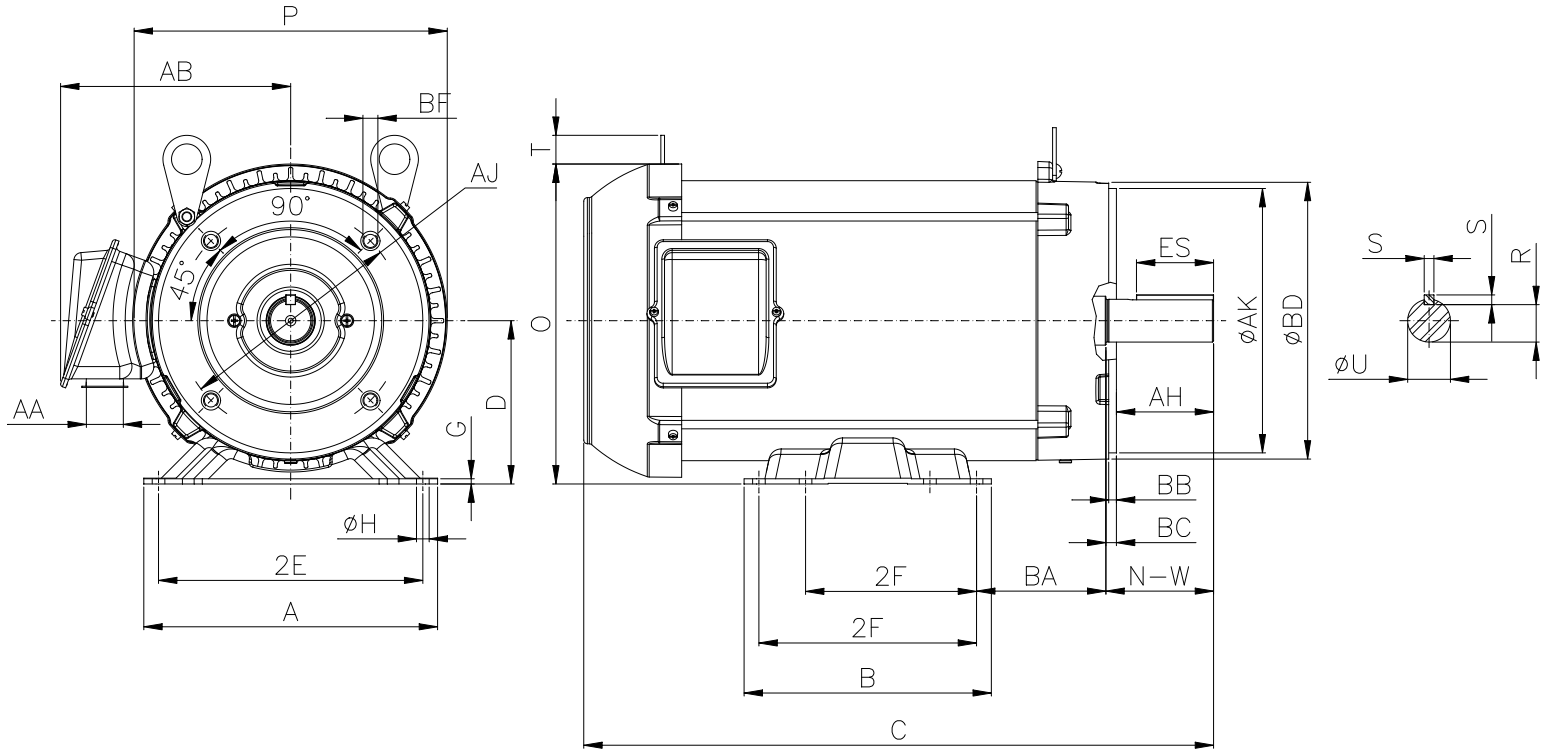

Notes: Downloaded from <http://dealerselectric.com>
Generated for Model #02018ET3ERS256TC

Performed by:

Checked:

Customer:

Three-Phase : Rolled Steel Motor - NEMA Premium Efficiency

2E 10.000	A 12.126	P 11.181	AB 7.819	2F 8.252/10.000
B 11.417	BA 4.750	U 1.625	N-W 4.000	ES 2.756
S 0.375	R 1.416	depth 0.375	D 6.250	G 0.187
O 11.841	T 0.688	H 0.531	C 24.925	d1 A 4
d2 A 4	Flange FC-184	AJ 7.250	AK 8.500	BD 8.875
BF UNC 1/2"x13	BB 0.250	BC 0.250	AH 3.750	

Three-phase induction motor
Frame 256T - IP55

23-SEP-2016

