

1 2 3 4 5 6 7 8

A

B

C

D

E

F

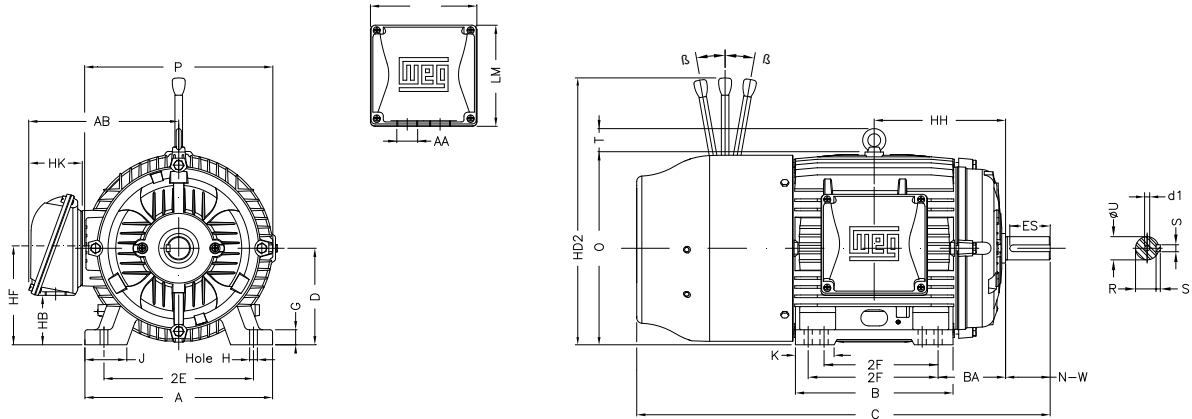

Notes: Downloaded from <http://dealerselectric.com>
Generated for Model #02018ET3EBM256T-W22

Performed by:

Checked:

Customer:

W22 Brake Motor - NEMA Premium Efficiency

Three-phase induction motor
Frame 254/6T - IP55

23-SEP-2016



2E 10.000	J 2.539	A 12.126	P 12.953	AB 10.483
2F 8.252/10.000	K 2.559	B 11.732	BA 4.250	U 1.625
N-W 4.000	ES 2.756	S 0.375	R 1.416	D 6.250
G 0.827	HB 3.061	O 12.598	HF 6.565	HH 9.250
HK 3.976	H 0.531	C 29.839	LL 7.815	LM 7.480
AA NPT 1 1/2"	HD' 10.896	d1 A 4	HD2 17.195	T 2.087