

1 2 3 4 5 6 7 8

A  
B  
C  
D  
E  
F

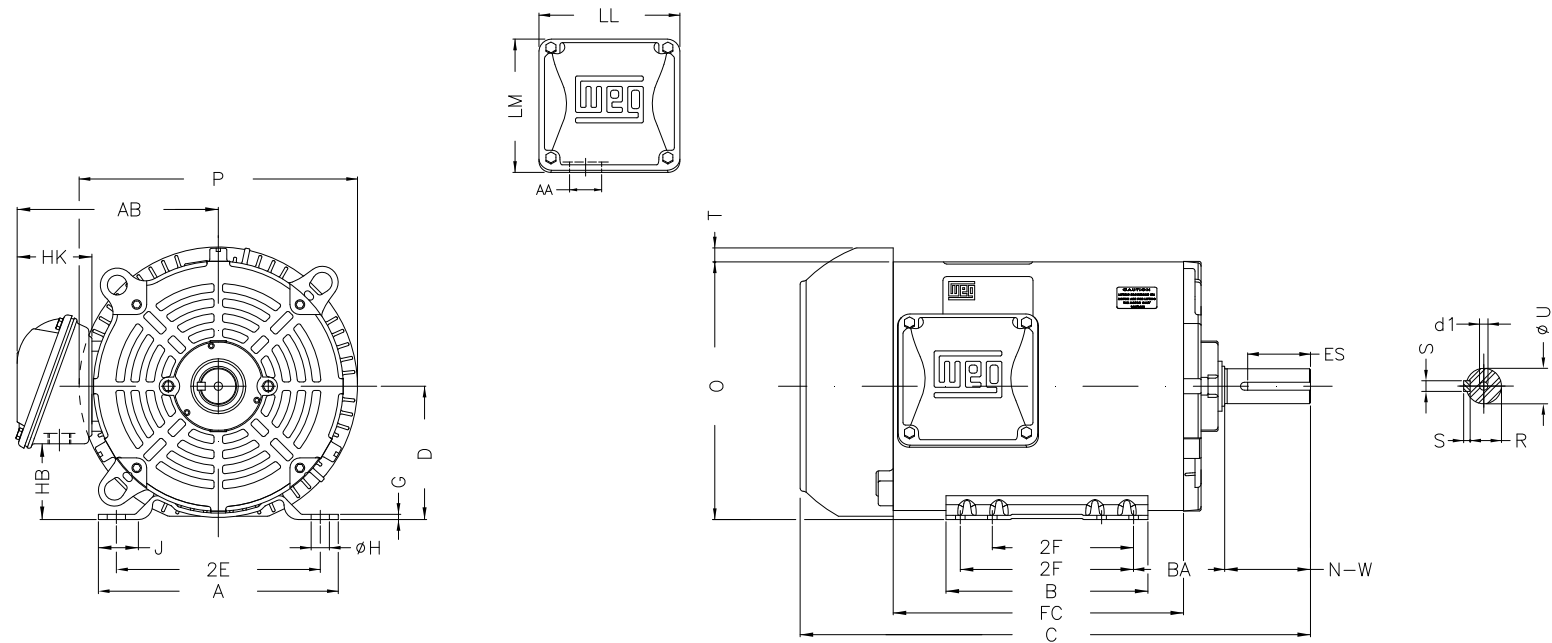

Notes: Downloaded from <http://dealerselectric.com>  
Generated for Model #02018ET3E256T-S

Performed by:

Checked:

Customer:

Three Phase: W01 (Rolled Steel) - TEFC - NEMA Premium Efficiency

P	AB	J	2E	A
13.180	9.448	1.693	10.000	11.417
H	G	HB	HK	T
0.530	0.187	3.631	3.645	0.830
O	FC	2F	B	C
12.010	13.780	8.252/10.000	11.417	23.346
BA	N-W	ES	d1	S
4.250	4.000	2.756	A4	0.375
U	AA	depth	R	LL
1.625	1.732"	0.375	1.416	6.299
LM	BB	D	CH	
6.017	0.830	6.250	1.929	

Three-phase induction motor  
Frame 254/6T - IP55

23-SEP-2016

