

1 2 3 4 5 6 7 8

A
B
C
D
E
F

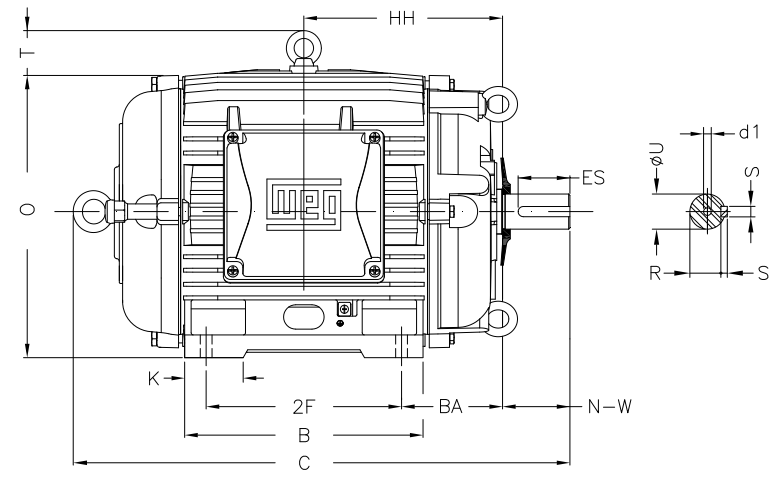
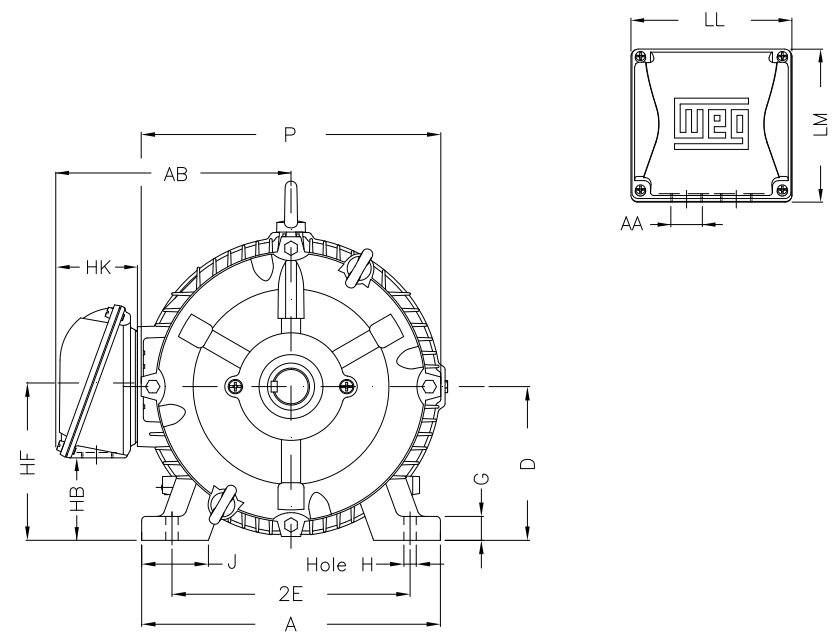

Notes: Downloaded from <http://dealerselectric.com>
Generated for Model #02018AT3ECT256TF1-W2

Performed by:

Checked:

Customer:

W22 Cooling Tower Motors: NEMA Premium - TEAO

2E	J	A	P	AB
10.000	2.539	12.126	12.480	10.483
2F	K	B	BA	U
10.000	2.559	11.732	4.250	1.625
N-W	ES	S	R	depth
4.000	2.756	0.375	1.406	0.375
D	G	HB	O	T
6.250	0.827	3.061	12.598	2.087
HF	HH	HK	H	C
6.565	9.250	3.987	0.531	23.343
LL	LM	AA	d1	
7.813	7.482	NPT 1 1/2"	A 4	

Three-phase induction motor
Frame 256T - IP55

23-SEP-2016

