

1 2 3 4 5 6 7 8

A
B
C
D
E
F

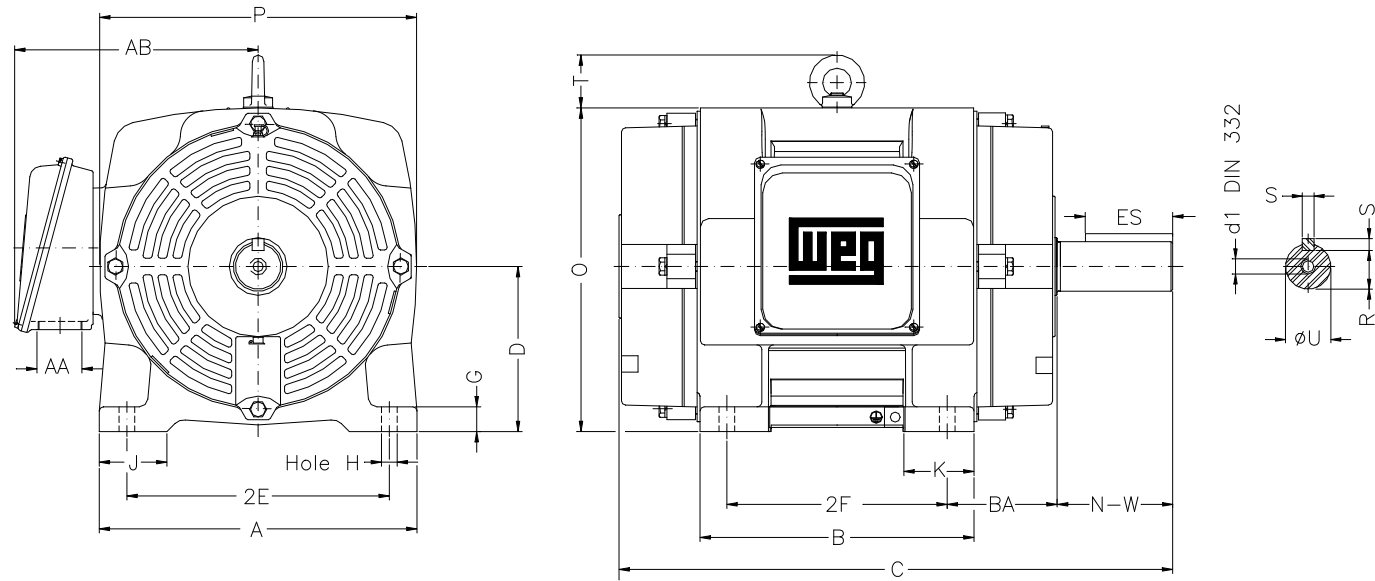

Notes: Downloaded from <http://dealerselectric.com>
Generated for Model #020120T3E286T-G

Performed by:

Checked:

Customer:

ODP General Purpose

Three-phase induction motor
Frame 286T - IP23

23-SEP-2016



2E 11.000	A 13.780	2F 11.000	B 13.070	BA 4.750
J 3.150	K 2.960	P 13.700	ES 3.149	depth 0.500
S 0.500	D 7.000	N-W 4.622	G 1.102	U 1.875
O 13.858	T 2.165	R 1.594	H 0.531	AB 10.886
C 24.882	AA NPT 1 1/2"	d1 A 4		