

1 2 3 4 5 6 7 8

A

B

C

D

E

F

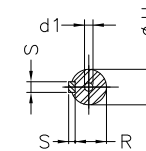
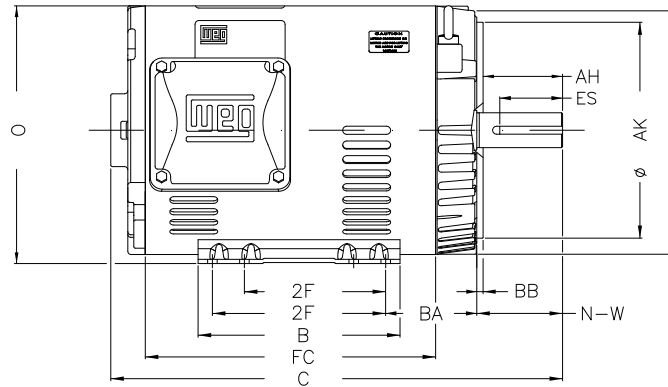
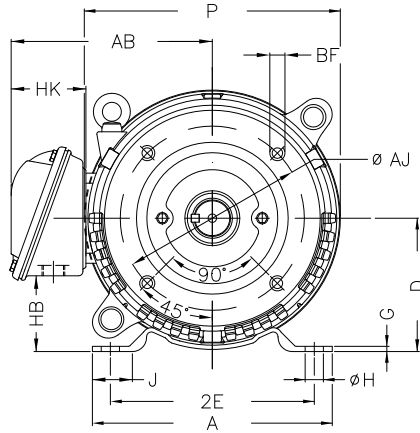
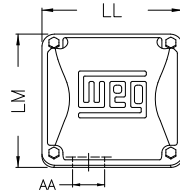

Notes: Downloaded from <http://dealerselectric.com>
Generated for Model #015180T3E254TC-S

Performed by:

Checked:

Customer:

Three Phase: W01 (Rolled Steel) - ODP - NEMA Premium Efficiency

Three-phase induction motor
Frame 254/6T - ODP

23-SEP-2016



P 11.558	AB 9.448	J 1.693	2E 10.000	A 11.417
H 0.530	G 0.187	HB 3.631	HK 3.645	T 0.019
O 12.010	FC 12.992	2F 8.252/10.000	B 11.417	C 20.472
BA 4.750	N-W 4.000	ES 2.756	d1 A 4	S 0.375
U 1.625	AA 1.732"	depth 0.375	R 1.416	LL 6.299
LM 6.017	D 6.250	CH 1.929	Flange FC-184	AJ 7.250
AK 8.500	BD 11.084	BF UNC 1/2"x13	BB 0.250	AH 3.750