

1 2 3 4 5 6 7 8

A

B

C

D

E

F

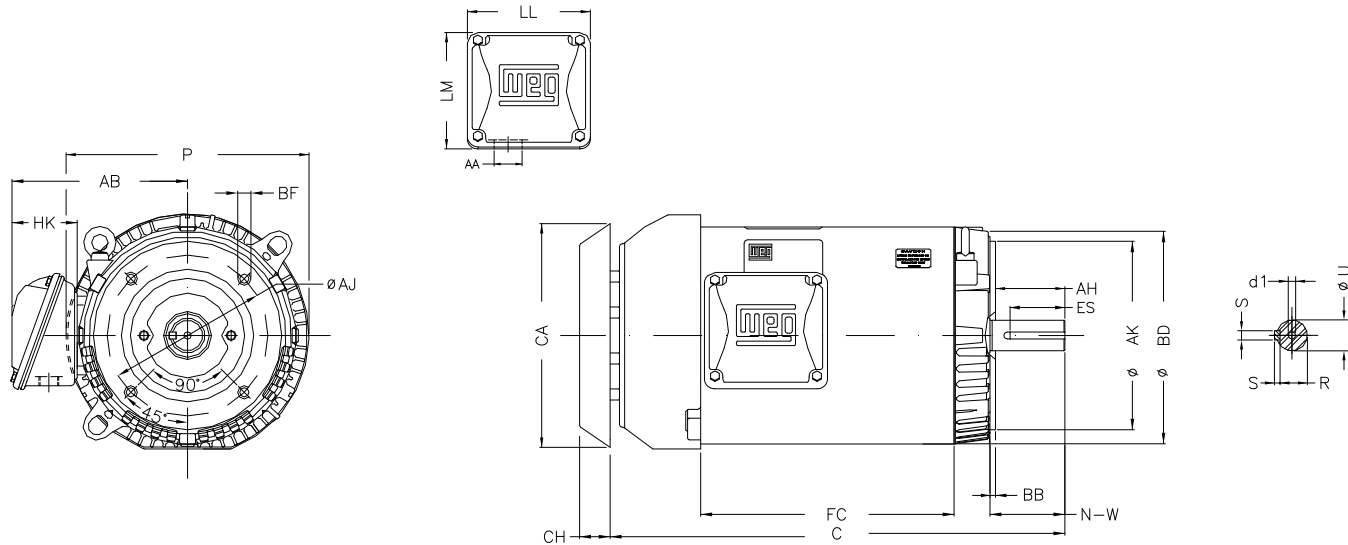

Notes: Downloaded from <http://dealerselectric.com>
Generated for Model #01518ET3HR254TC-S

Performed by:

Checked:

Customer:

Three Phase: W01 (Rolled Steel) - TEFC - NEMA Premium Efficiency

Three-phase induction motor
Frame 254/6T - IP55

23-SEP-2016



P	AB	HK	FC	C
13.180	9.448	3.645	12.992	22.559
N-W	ES	d1	S	U
4.000	2.756	A 4	0.375	1.625
AA	depth	R	LL	LM
1.732"	0.375	1.416	6.299	6.017
CH	Flange	AJ	AK	BD
1.929	FC-184	7.250	8.500	11.084
BF	BB	AH		
UNC 1/2"x13	0.250	3.750		