

1 2 3 4 5 6 7 8

A
B
C
D
E
F

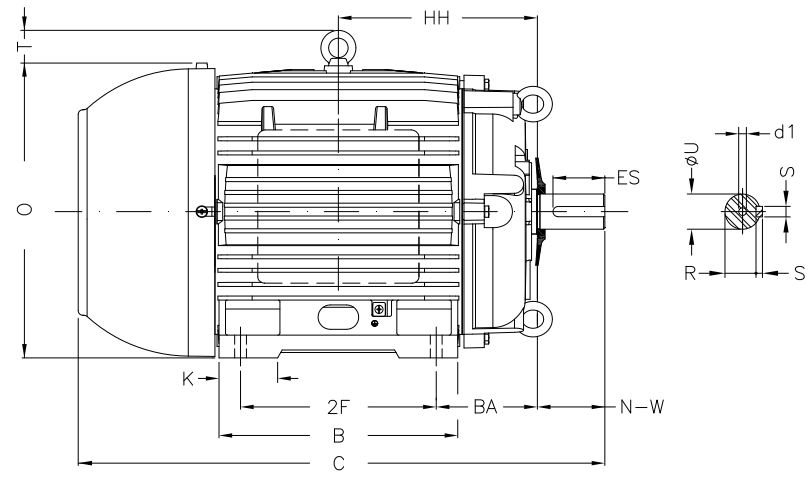
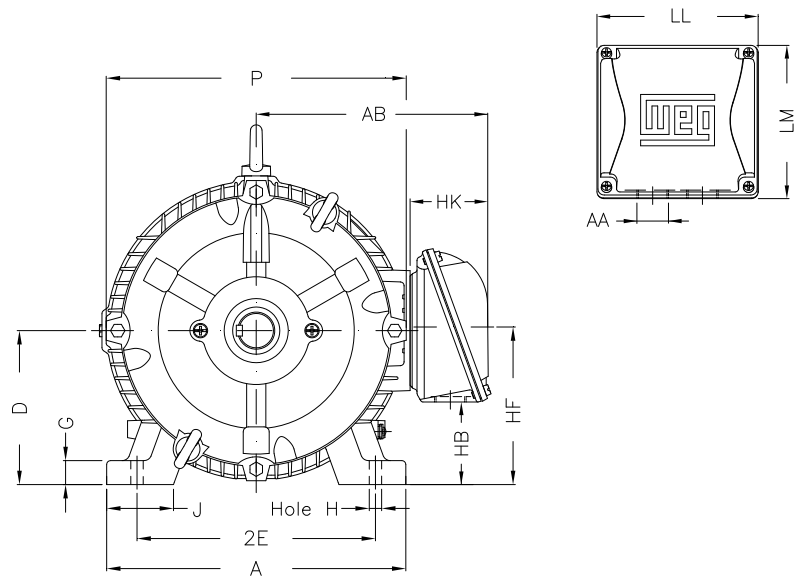

Notes: Downloaded from <http://dealerselectric.com>
Generated for Model #01518ET3ECT254T-W22

Performed by:

Checked:

Customer:

W22 Cooling Tower Motors: NEMA Premium - TEFC

Three-phase induction motor
Frame 254T - IP55

23-SEP-2016



2E 10.000	J 2.539	A 12.126	P 12.480	AB 10.483
2F 8.252	K 2.559	B 10.000	BA 4.250	U 1.625
N-W 4.000	ES 2.756	S 0.375	R 1.416	depth 0.375
D 6.250	G 0.827	HB 3.061	O 12.598	T 2.087
HF 6.565	HH 8.376	HK 3.976	H 0.531	C 23.213
LL 7.815	LM 7.480	AA NPT 1 1/2"	d1 A 4	d2 A 4