

1 2 3 4 5 6 7 8

A

B

C

D

E

F

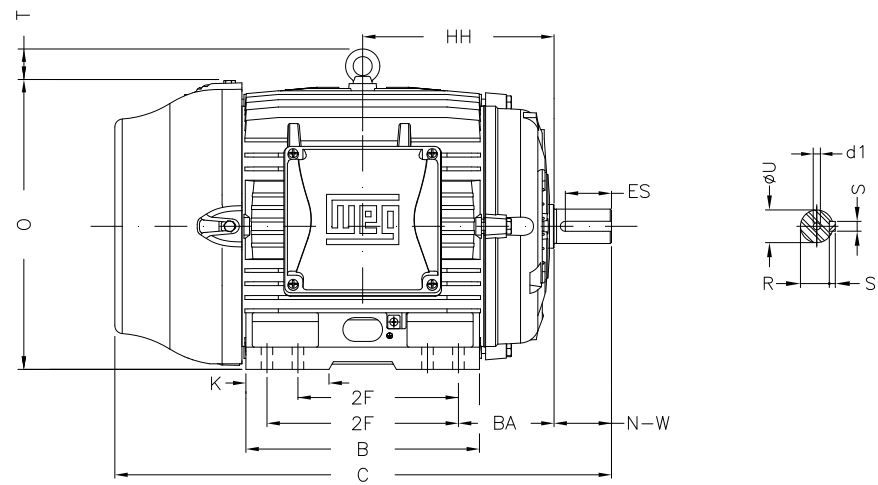
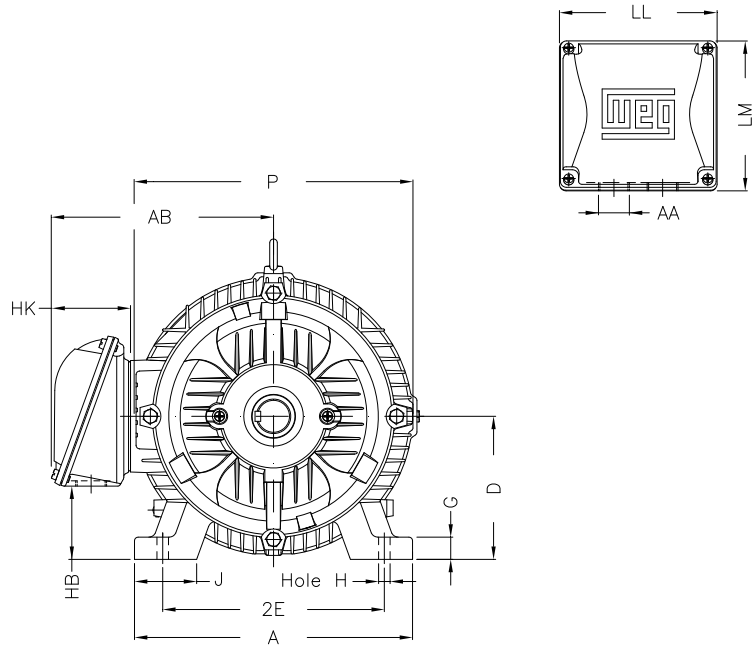

Notes: Downloaded from <http://dealerselectric.com>
Generated for Model #01518ET3E254T-W22

Performed by:

Checked:

Customer:

W22 NEMA Premium - Ball Bearings

Three-phase induction motor
Frame 254/6T - IP55

23-SEP-2016



2E 10.000	J 2.539	A 12.126	P 12.953	AB 10.483
2F 8.252/10.000	K 2.559	B 11.732	BA 4.250	FBA 6.852
U 1.625	N-W 4.000	ES 2.756	S 0.375	R 1.416
depth 0.375	D 6.250	G 0.827	HB 3.061	O 12.598
T 2.087	HF 6.565	HH 9.250	HK 3.976	H 0.531
C 24.945	LL 7.815	LM 7.480	AA NPT 1 1/2"	d1 A 4