

1 2 3 4 5 6 7 8

A

B

C

D

E

F

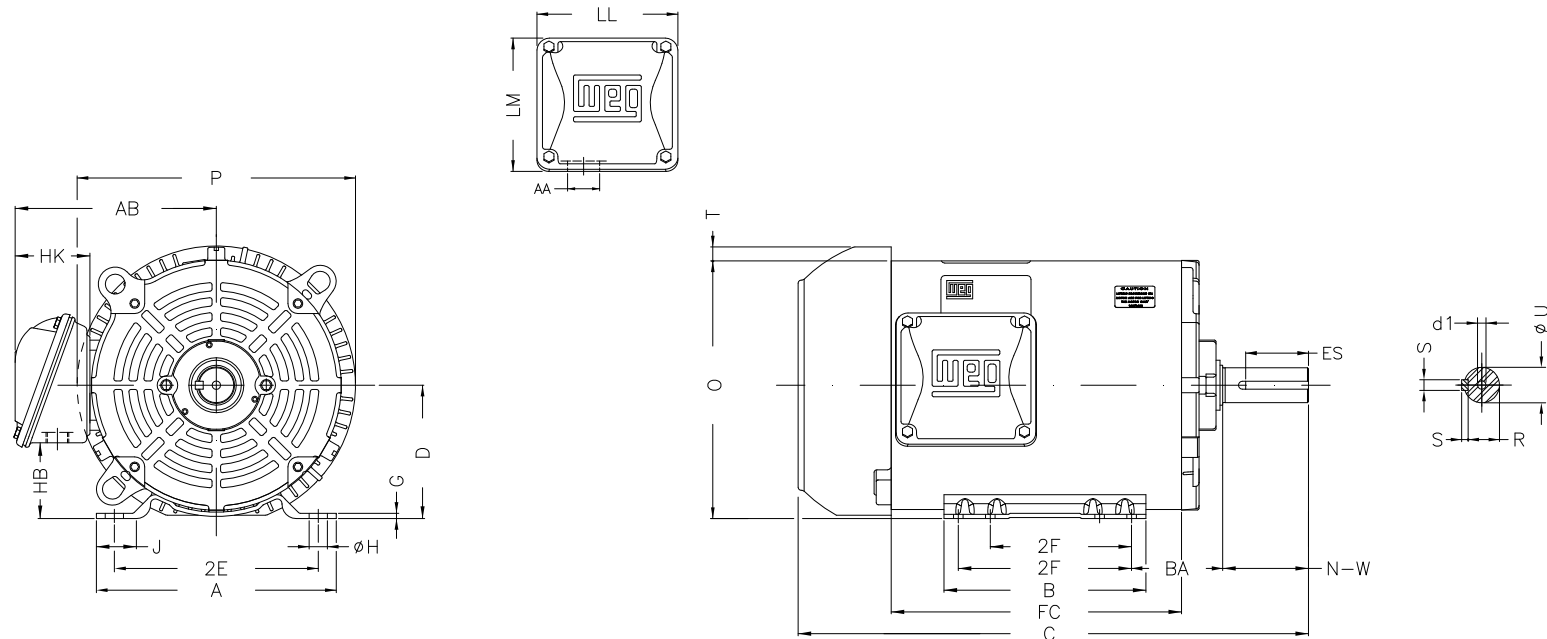

Notes: Downloaded from <http://dealerselectric.com>
Generated for Model #01518ET3E254T-SG

Performed by:

Checked:

Customer:

W01 (Rolled Steel) General Purpose TEFC

Three-phase induction motor
Frame 254/6T - IP55

23-SEP-2016



| | | | | |
|--------|--------|--------------|--------|--------|
| P | AB | J | 2E | A |
| 13.180 | 9.448 | 1.693 | 10.000 | 11.417 |
| H | G | HB | HK | T |
| 0.530 | 0.187 | 3.631 | 3.645 | 0.830 |
| O | FC | 2F | B | C |
| 12.010 | 12.992 | 8.252/10.000 | 11.417 | 22.559 |
| BA | N-W | ES | d1 | S |
| 4.250 | 4.000 | 2.756 | A4 | 0.375 |
| U | AA | depth | R | LL |
| 1.625 | 1.732" | 0.375 | 1.416 | 6.299 |
| LM | BB | D | CH | |
| 6.017 | 0.830 | 6.250 | 1.929 | |