

1 2 3 4 5 6 7 8

A

B

C

D

E

F

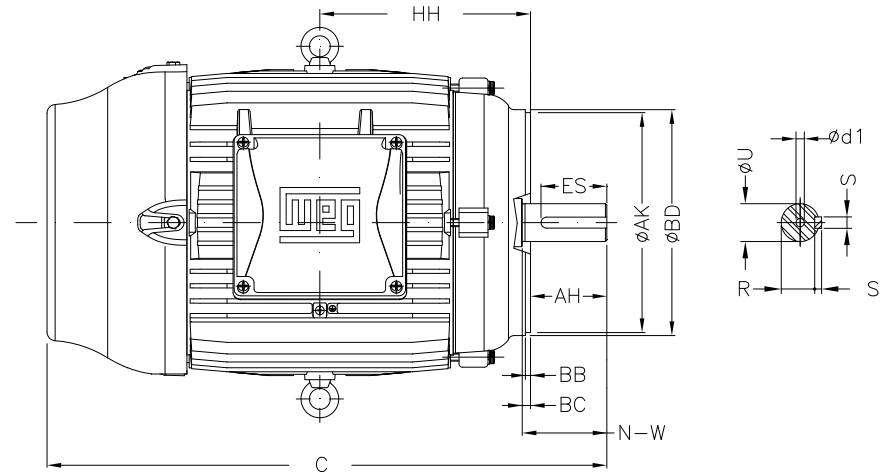
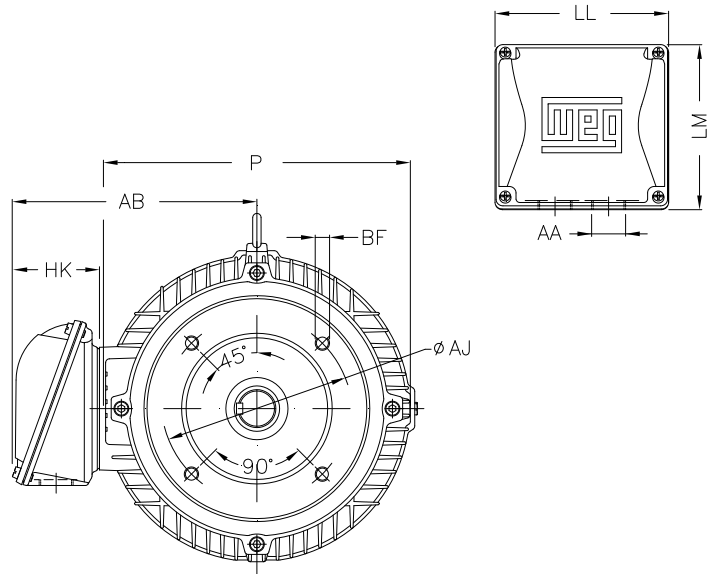

Notes: Downloaded from <http://dealerselectric.com>
Generated for Model #01518EP3ER254TC-W22

Performed by:

Checked:

Customer:

W22 High Efficiency

Three-phase induction motor
Frame 254T - IP55

23-SEP-2016



P	AB	U	N-W	ES
12.953	10.483	1.625	4.000	2.756
S	R	depth	HH	HK
0.375	1.416	0.375	8.376	3.976
C	LL	LM	AA	d1
23.213	7.815	7.480	NPT 1 1/2"	A 4
Flange	AJ	AK	BD	BF
FC-184	7.250	8.500	8.875	UNC 1/2"x13
BB	BC	AH		
0.250	0.250	3.750		