

1 2 3 4 5 6 7 8

A

B

C

D

E

F

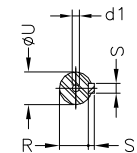
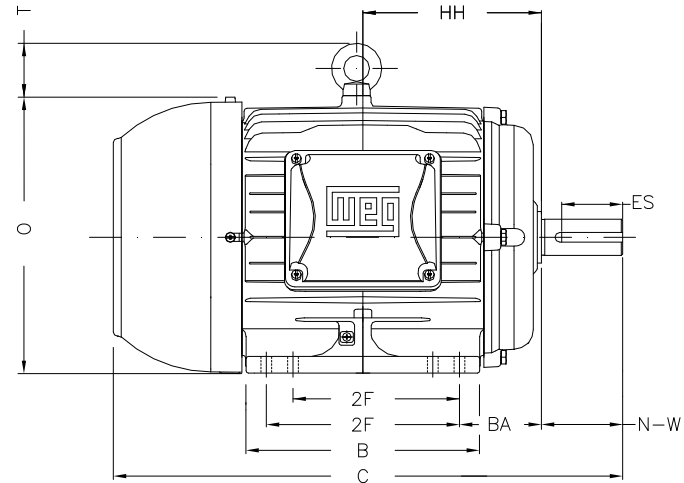
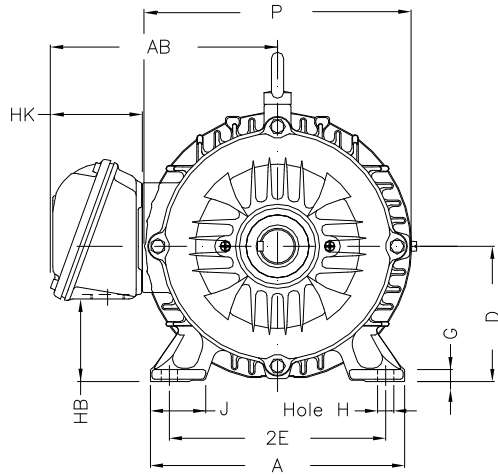
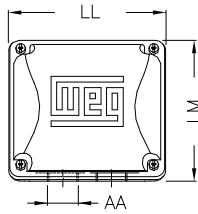

Notes: Downloaded from <http://dealerselectric.com>
Generated for Model #01036ST3QIE215T-W22

Performed by:

Checked:

Customer:

Three-Phase: W22 IEEE-841™ Petrochem Motors - NEMA Premium® Efficiency

Three-phase induction motor
Frame 213/5T - IP55

23-SEP-2016



2E 8.500	J 1.772	A 9.764	P 10.669	AB 8.583
2F 5.500/7.000	K 2.165	B 8.858	BA 3.500	U 1.375
N-W 3.375	ES 2.756	S 0.313	R 1.203	depth 0.313
D 5.250	G 0.649	HB 2.985	O 10.841	T 1.772
HF 5.250	HH 7.000	HK 3.150	H 0.406	C 19.517
LL 5.512	LM 5.236	AA NPT 1"	d1 A 4	d2 A 4