

1 2 3 4 5 6 7 8

A

B

C

D

E

F

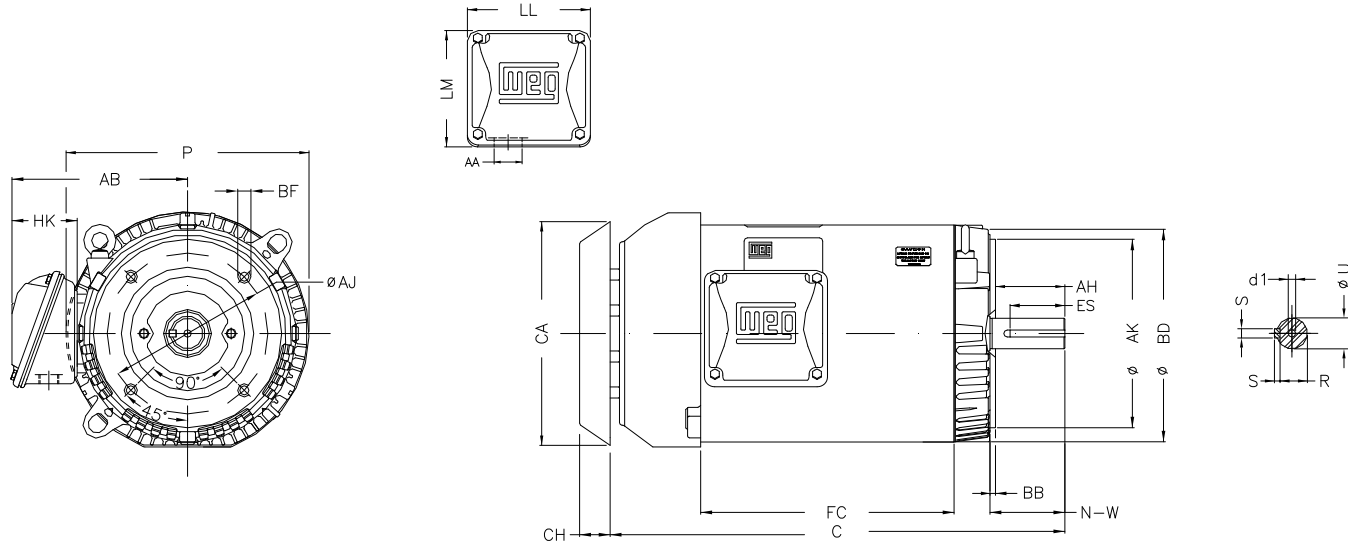

Notes: Downloaded from <http://dealerselectric.com>
Generated for Model #01036ET3ER215TC-S

Performed by:

Checked:

Customer:

Three Phase: W01 (Rolled Steel) - TEFC - NEMA Premium Efficiency

Three-phase induction motor
Frame 213/5T - IP55

13-SEP-2016



P	AB	HK	FC	C
10.965	7.973	3.022	12.992	21.654
N-W	ES	d1	S	U
3.380	2.480	A 4	0.313	1.375
AA	depth	R	LL	LM
1.377"	0.313	1.203	5.551	5.250
CH	Flange	AJ	AK	BD
1.929	FC-184	7.250	8.500	9.401
BF	BB	AH		
UNC 1/2"x13	0.250	3.129		