

1 2 3 4 5 6 7 8

A
B
C
D
E
F

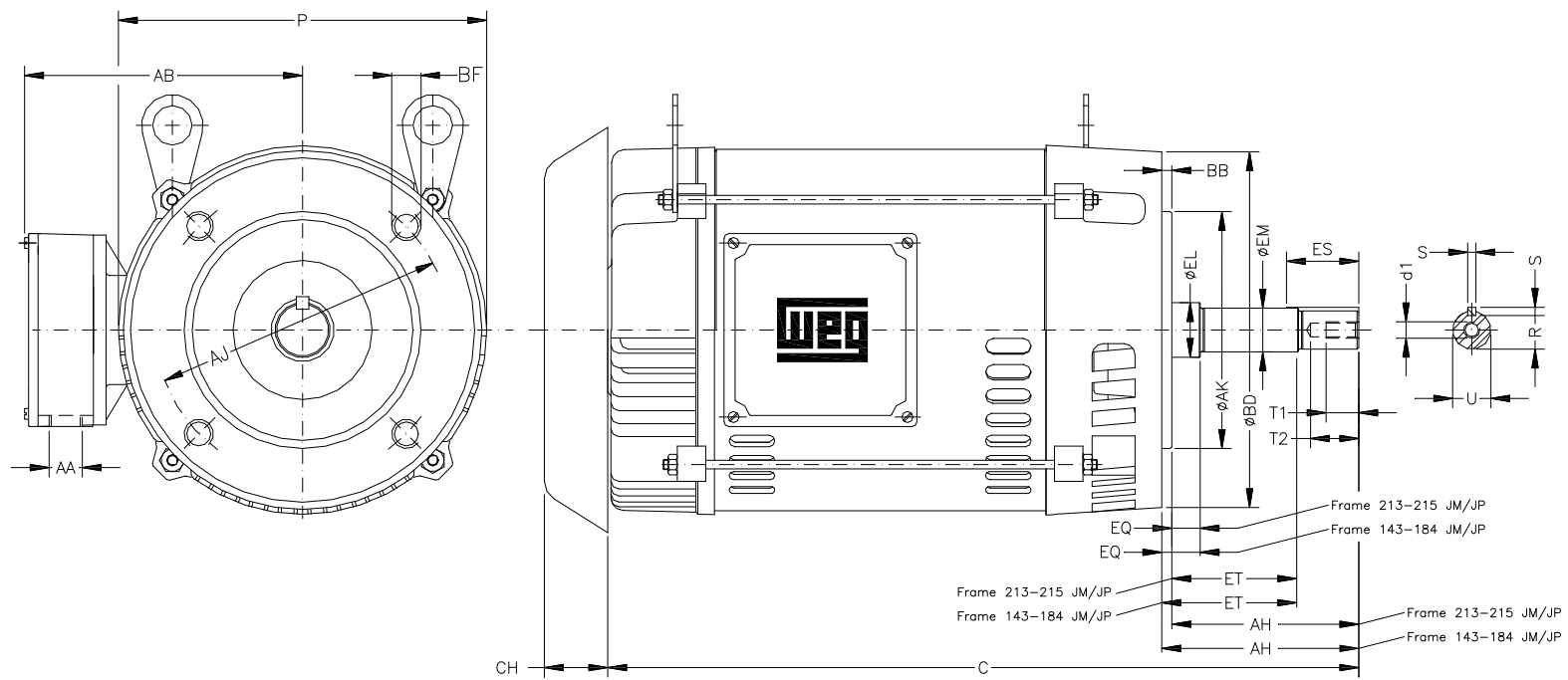

Notes: Downloaded from <http://dealerselectric.com>
Generated for Model #01018OP3E215JMV

Performed by:

Checked:

Customer:

Close Coupled Pump : Three-Phase - "JM" Type - ODP - High Efficiency -

P	AB	EQ	ET	U
8.779	8.149	0.630	2.880	0.874
EM	EL	S	EP	R
1.000	1.250	0.187	1.769	0.768
ES	d1	t1	t2	C
1.575	EUNC 3/8"-16	0.748	1.102	17.323
Flange	AJ	AK	BD	BF
FC-184	7.250	8.500	8.858	UNC 1/2"x13
BB	AH			
0.250	4.258			

Three-phase induction motor
Frame 213/5JM - IP21

13-SEP-2016

